

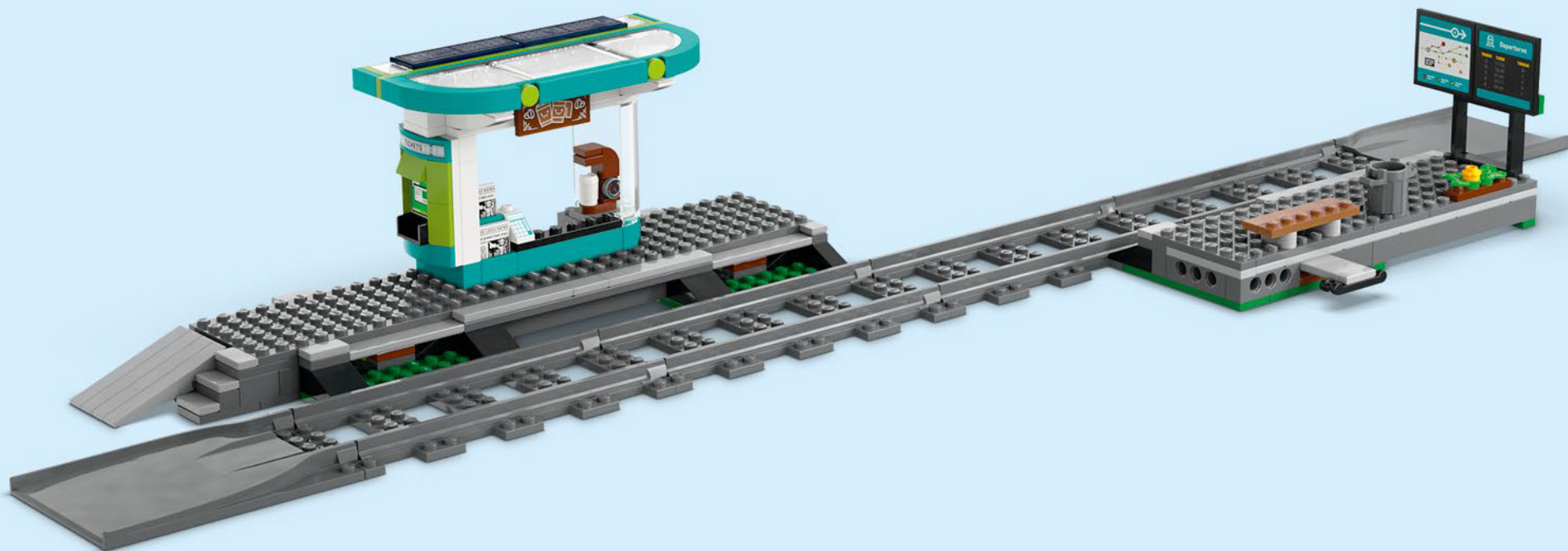

CITY

60423



8

9

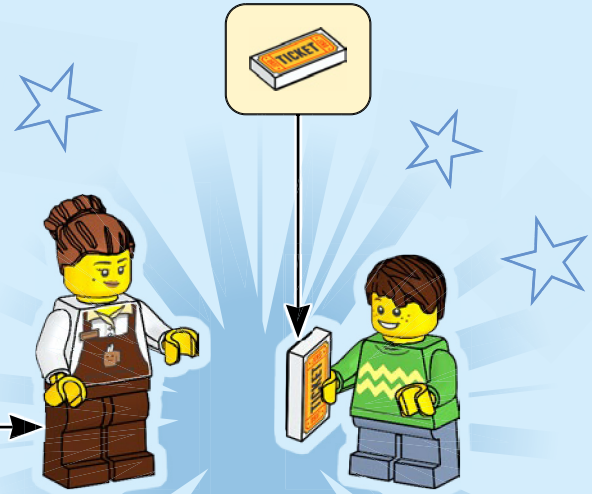

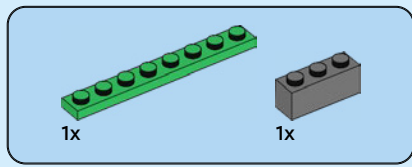

1

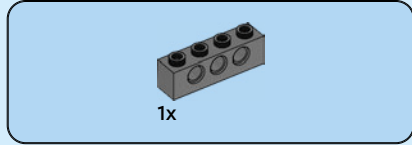
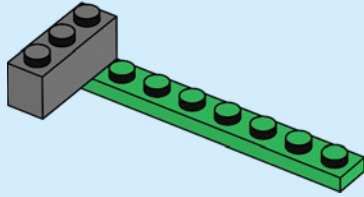

2

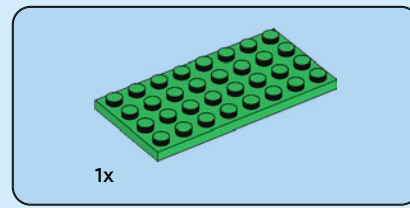
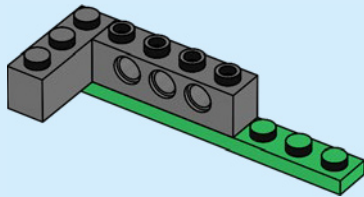

3

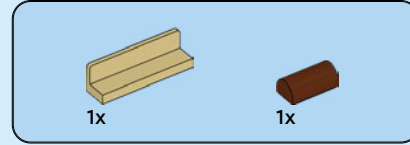
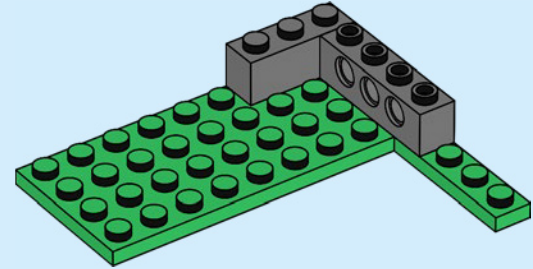

4

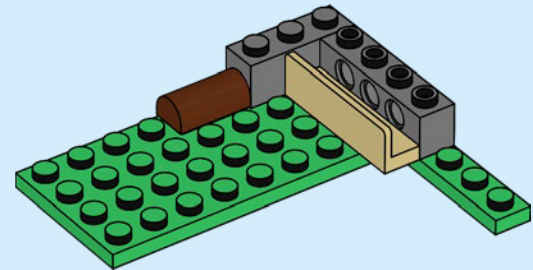

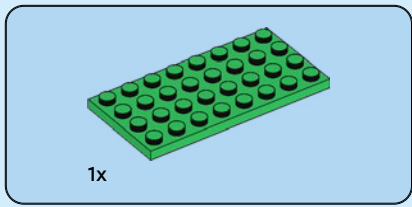

5

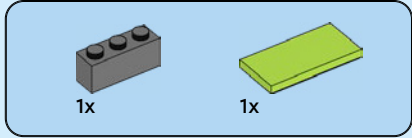
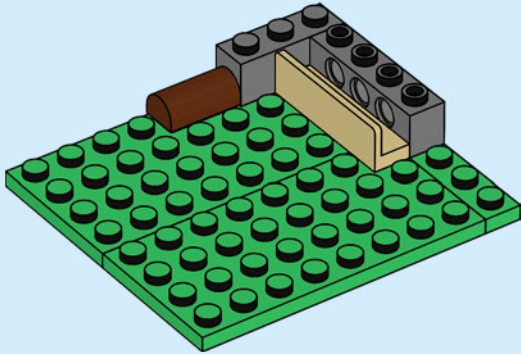

6

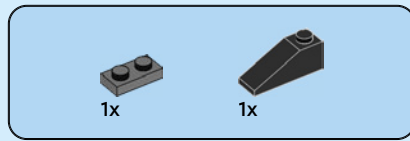
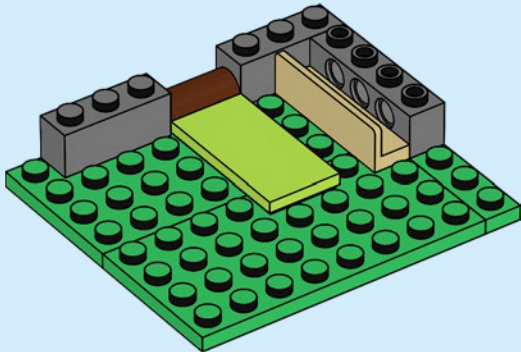

7

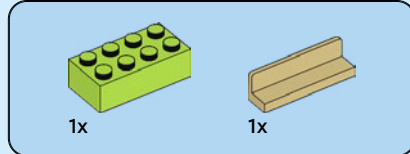
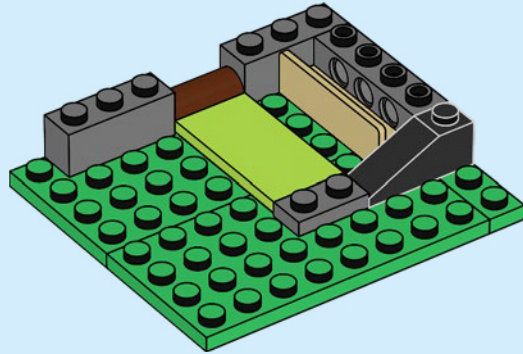

8

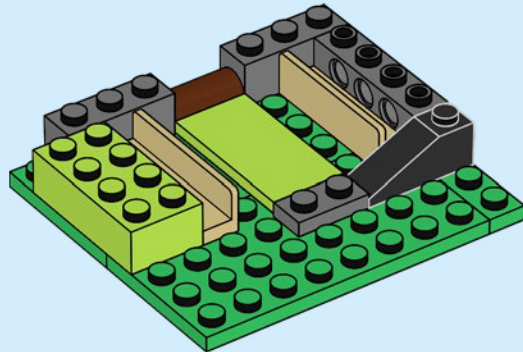

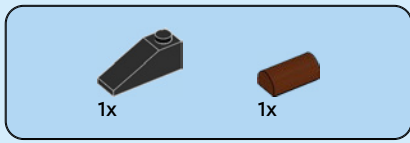

9

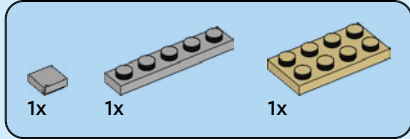
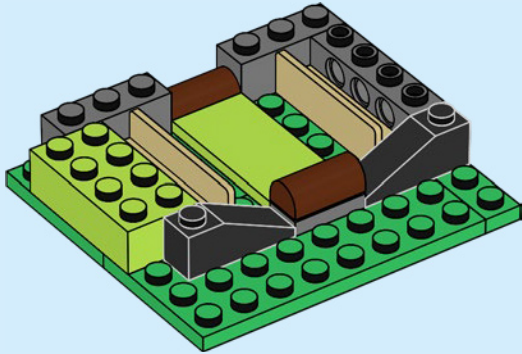

10

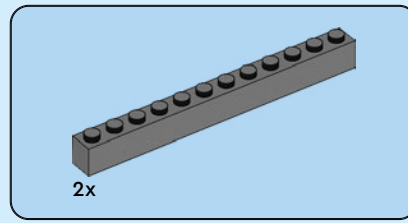
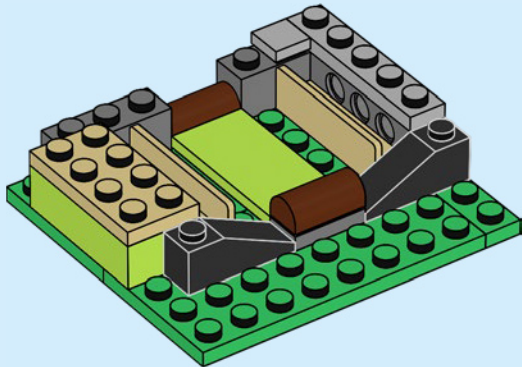

11

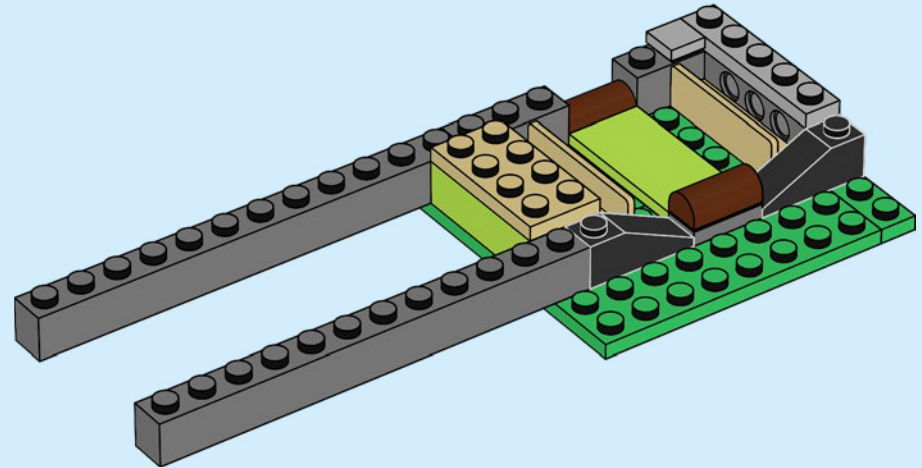

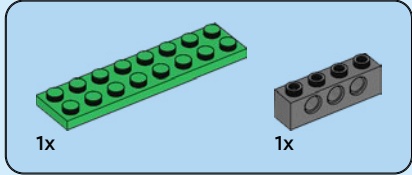
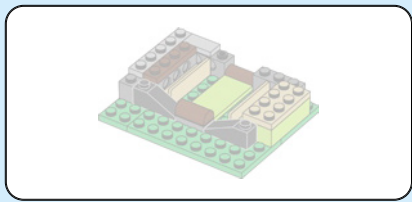

12

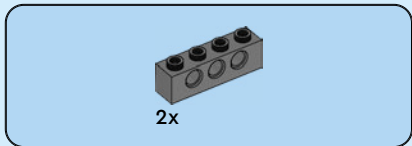
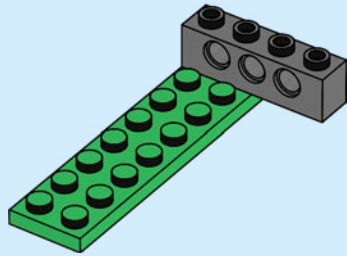

13

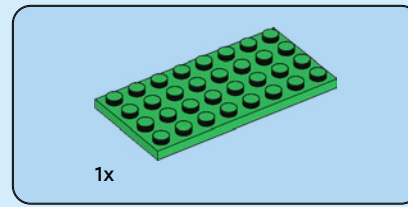
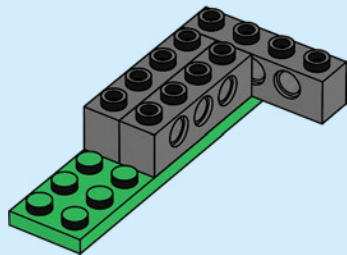

14

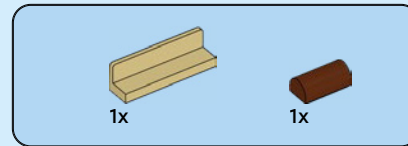
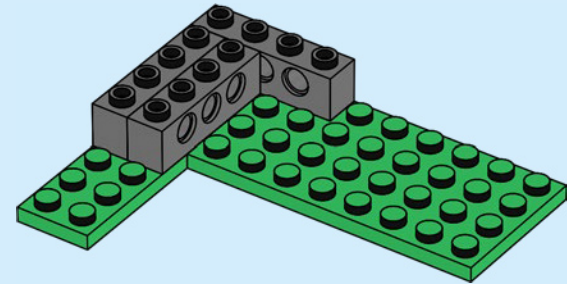

15

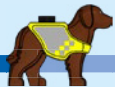
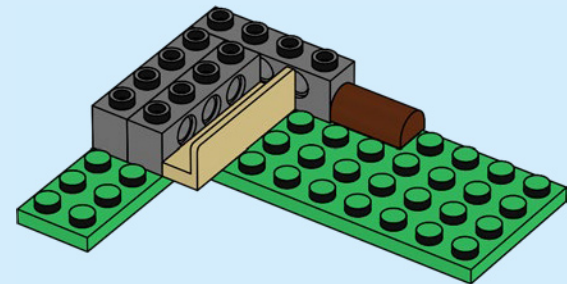

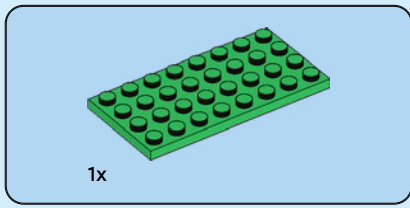

16

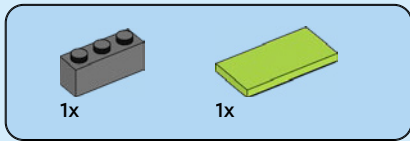
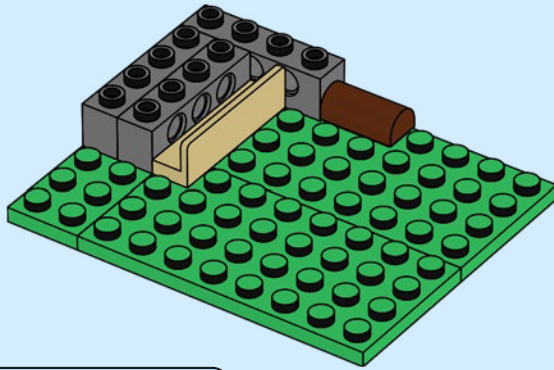

17

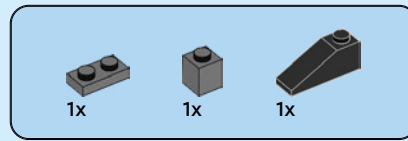
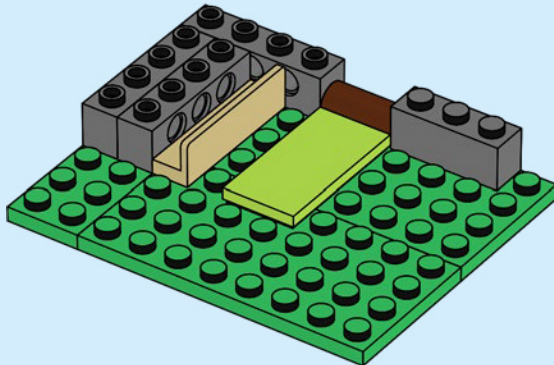

18

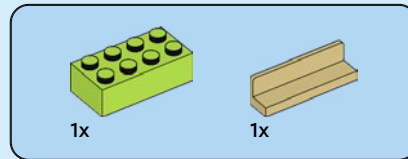
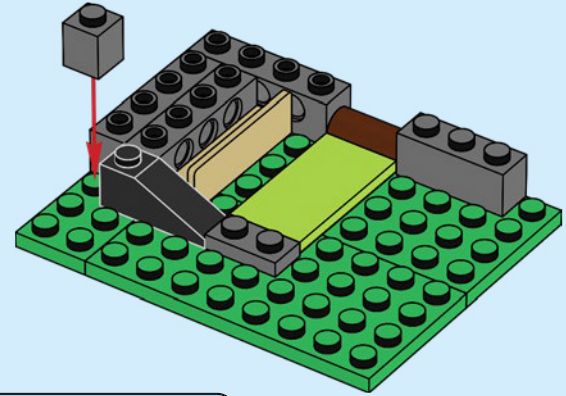

19

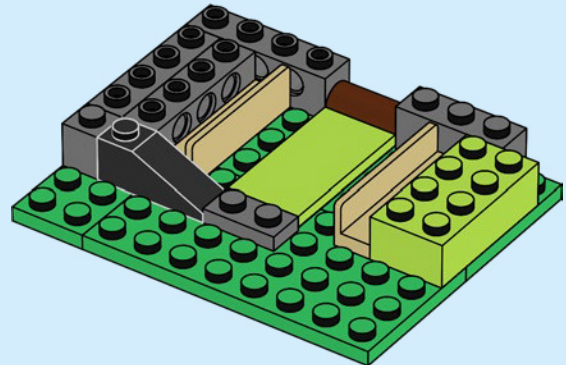

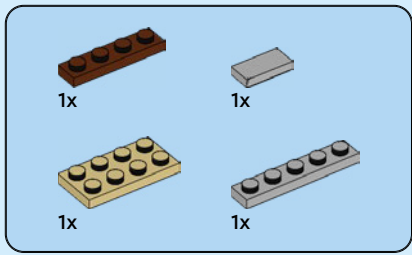

20

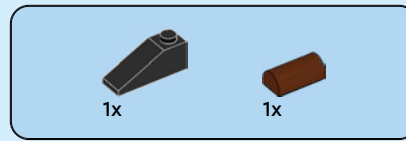
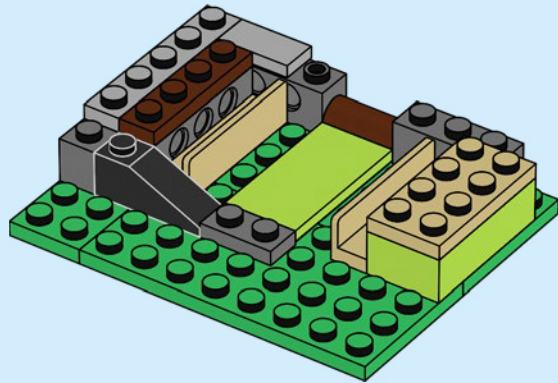

21

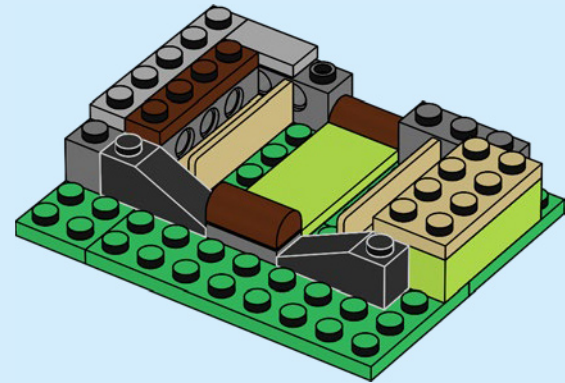

22

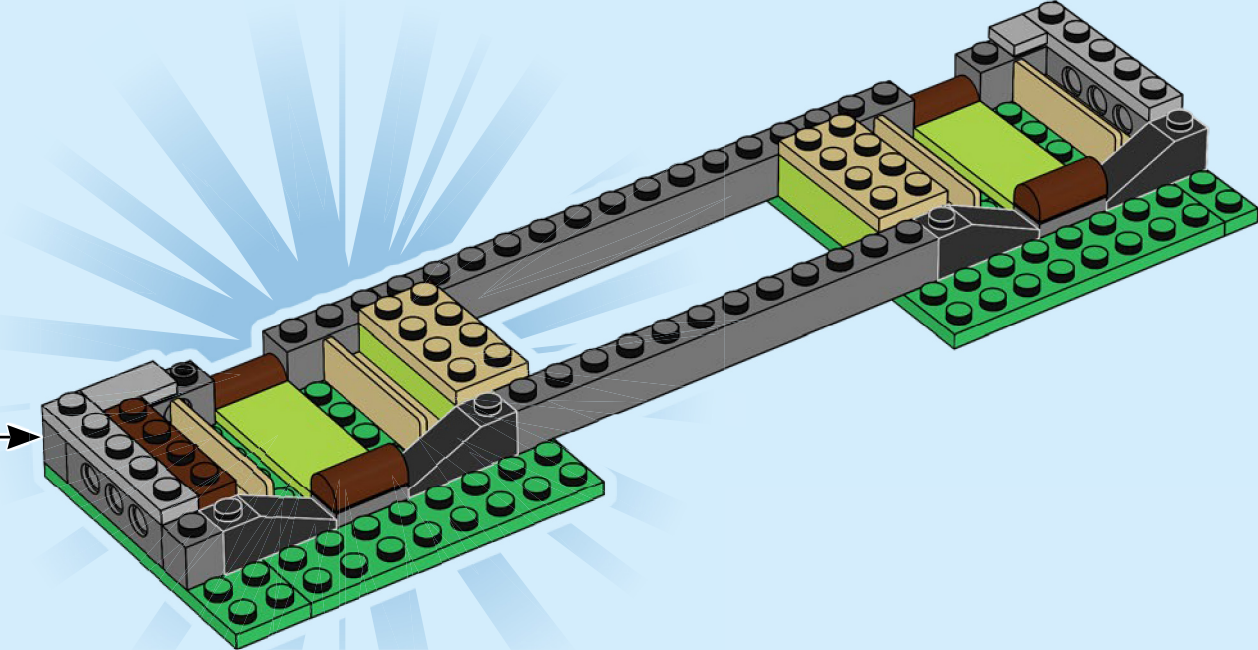

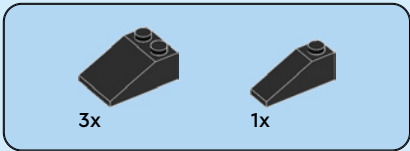

23

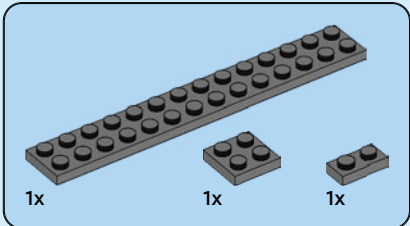
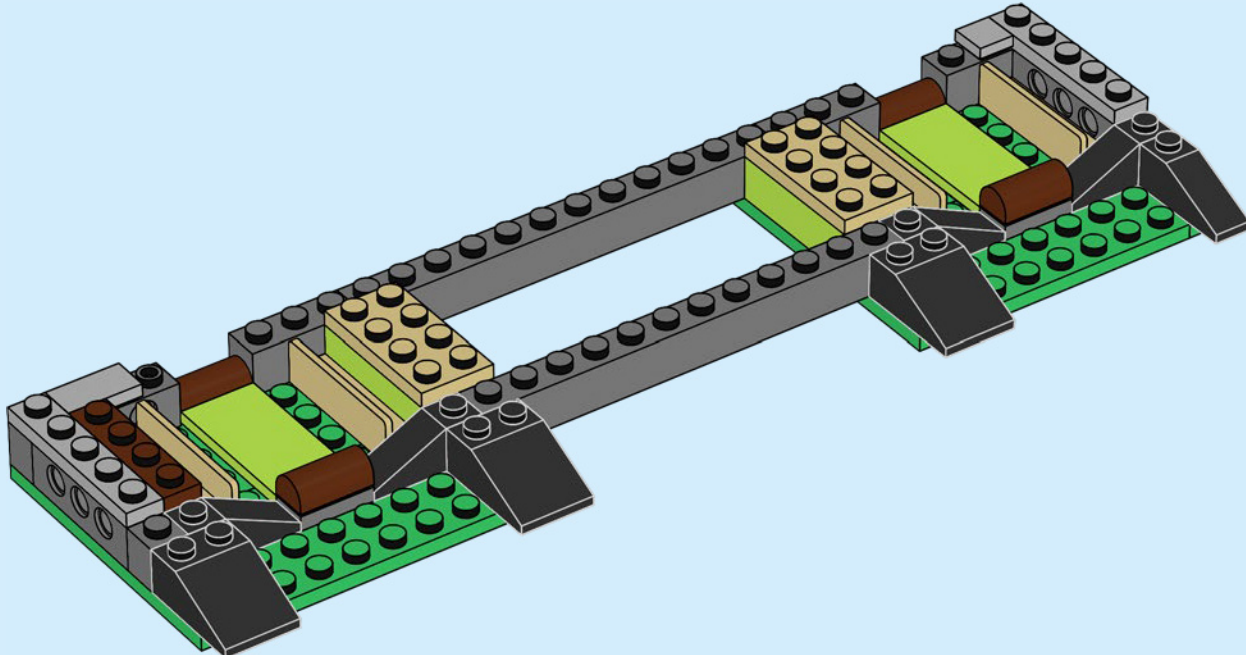

24

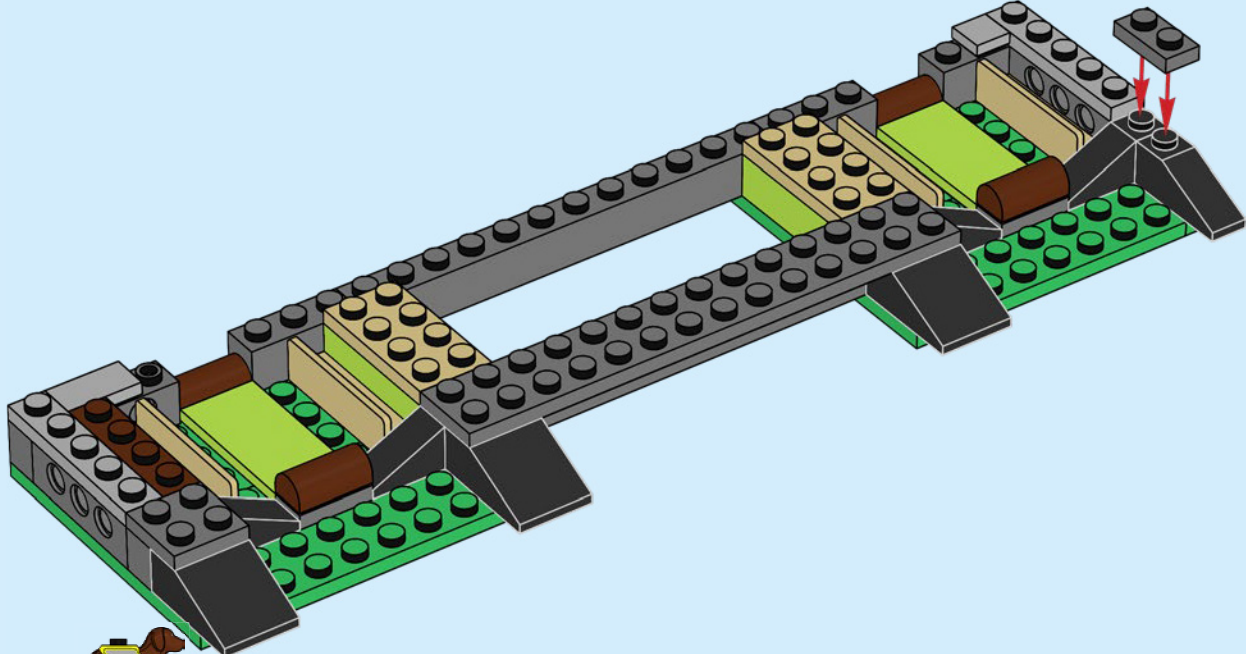

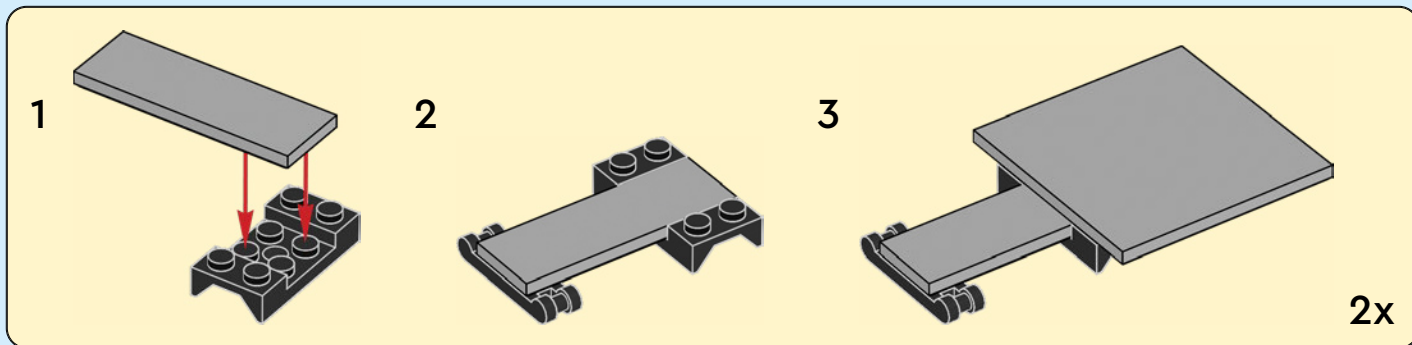
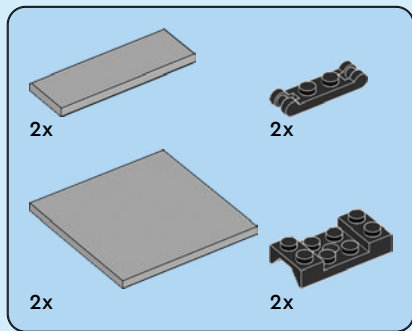

25

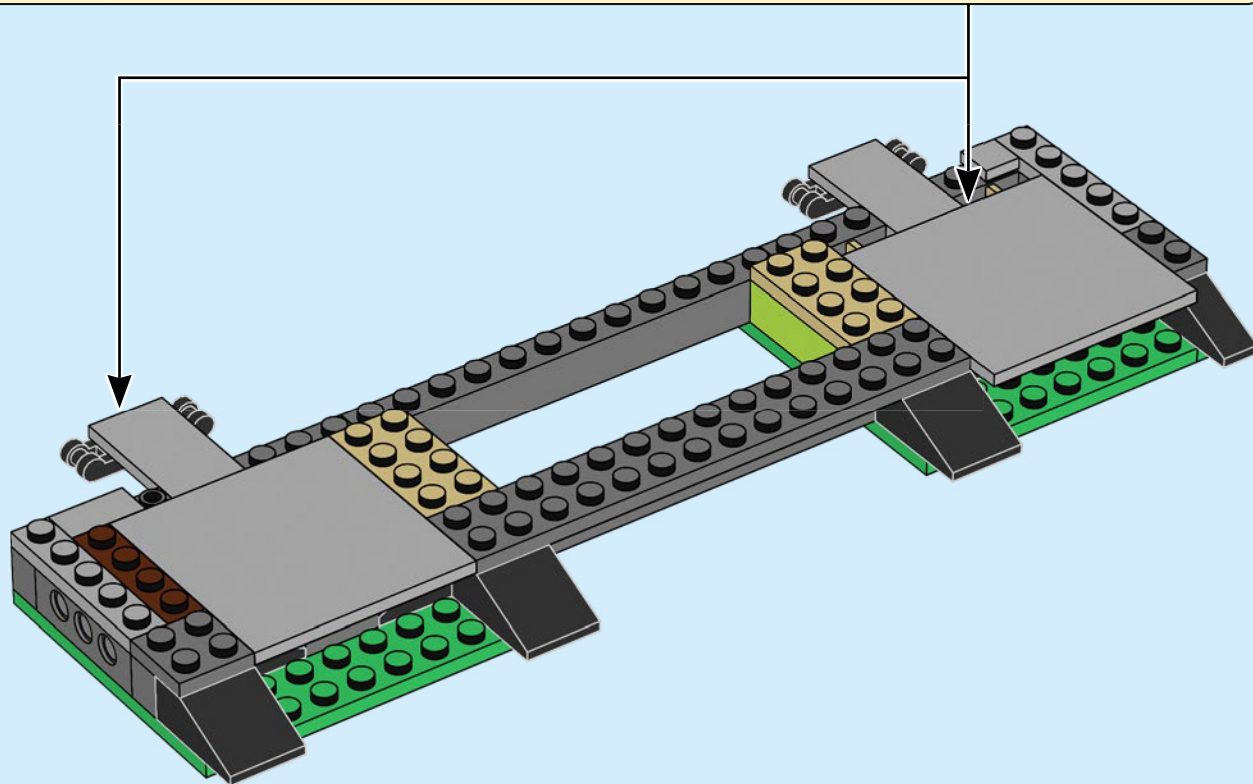

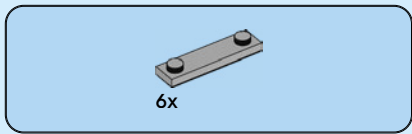

26

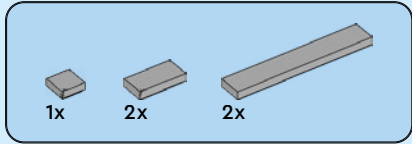
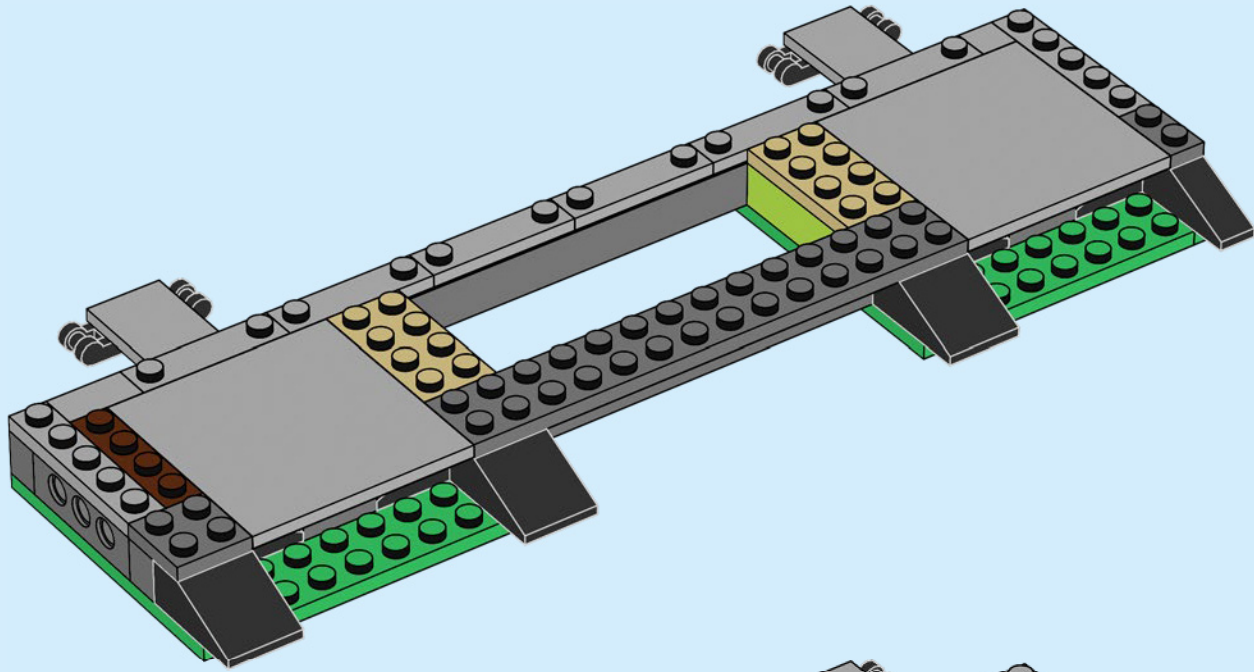

27

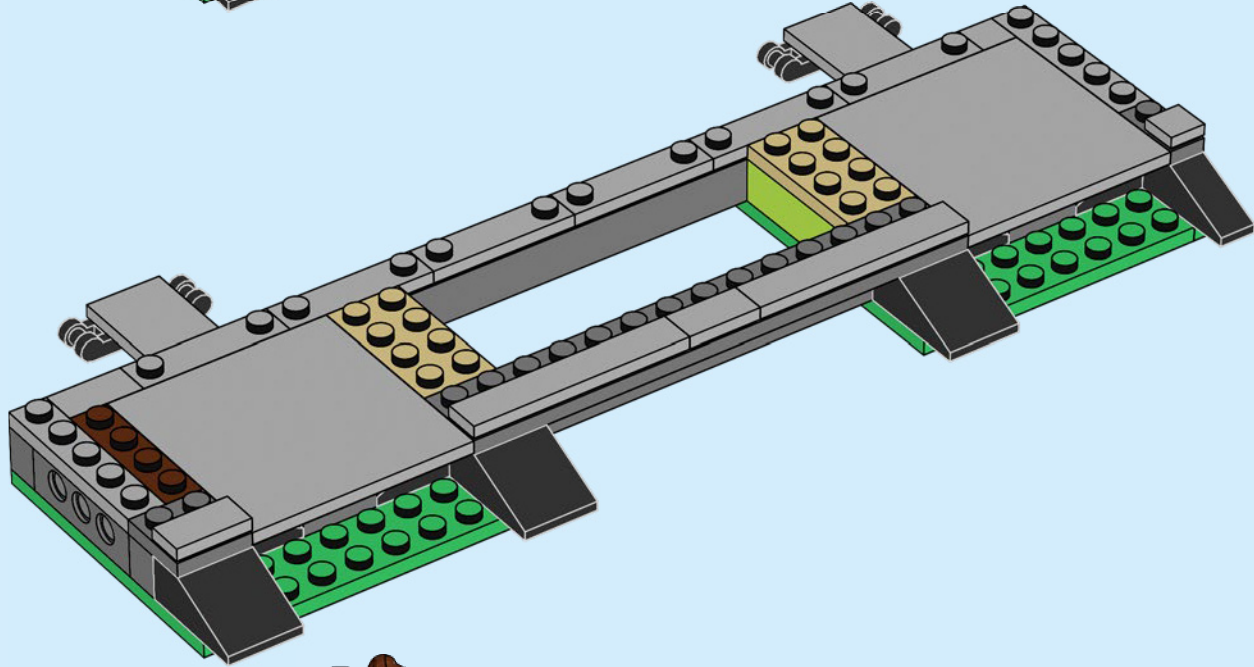

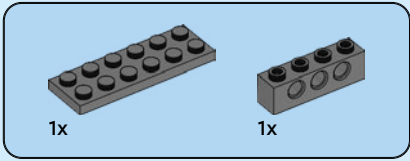
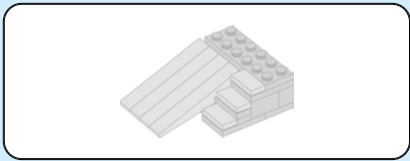

28

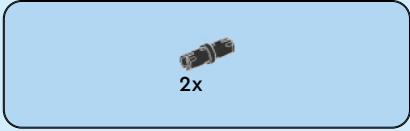
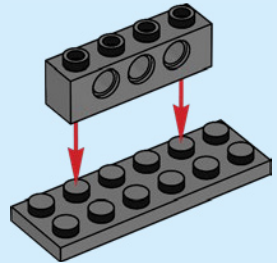

29

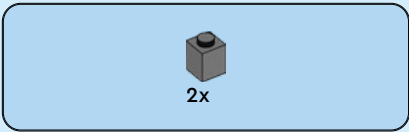
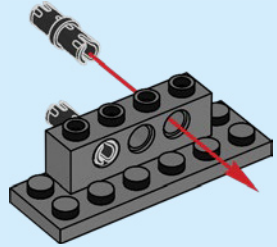

2x

30

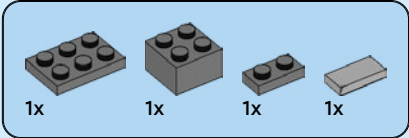
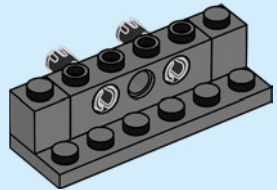

31

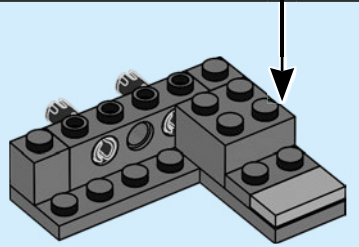
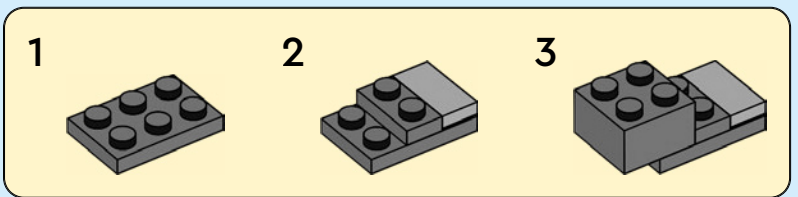

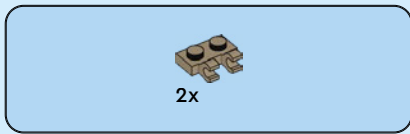

32

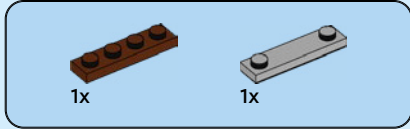
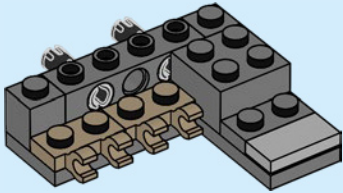

33

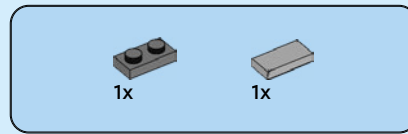
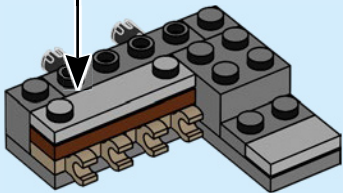
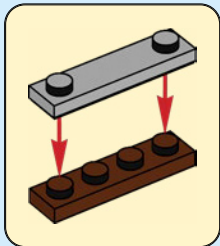

34

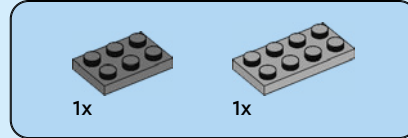
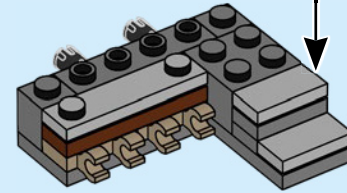
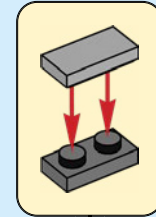

35

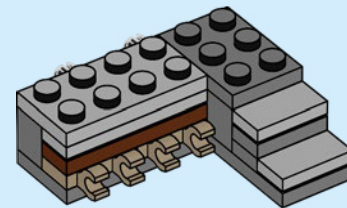

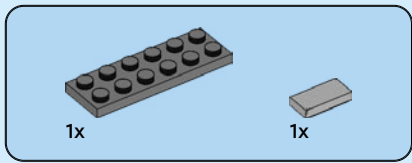

36

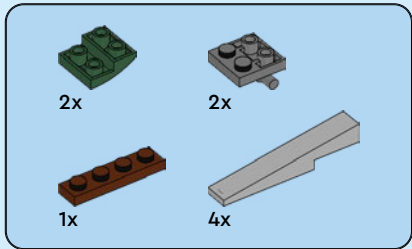
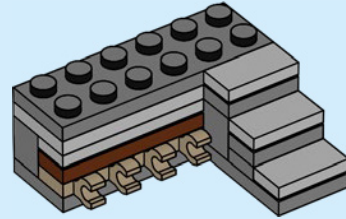

37

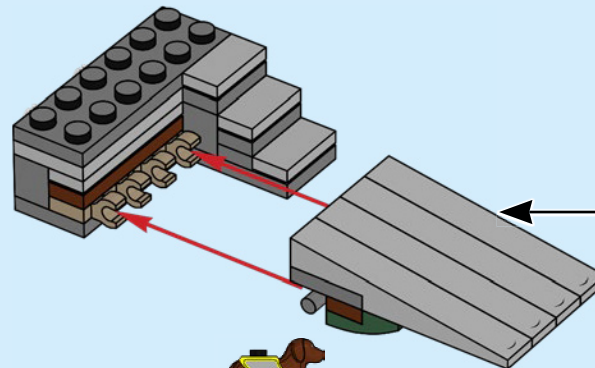
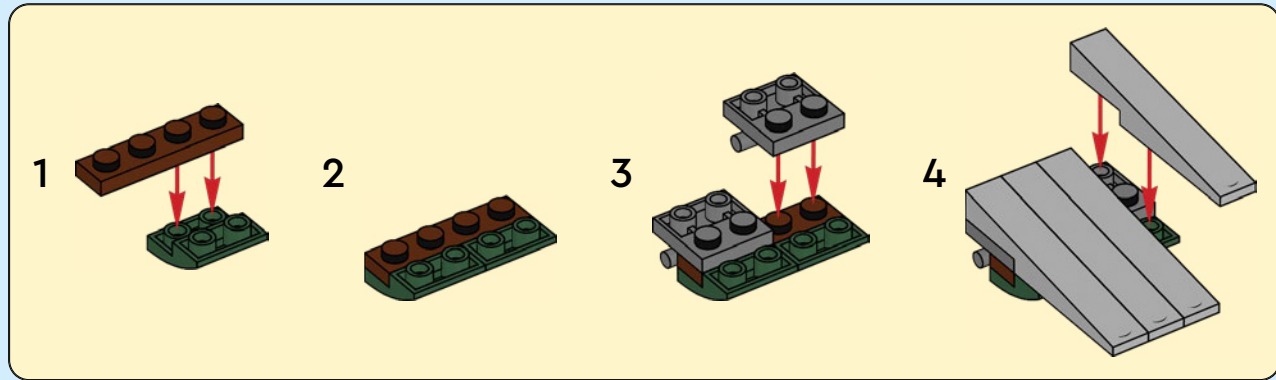

38

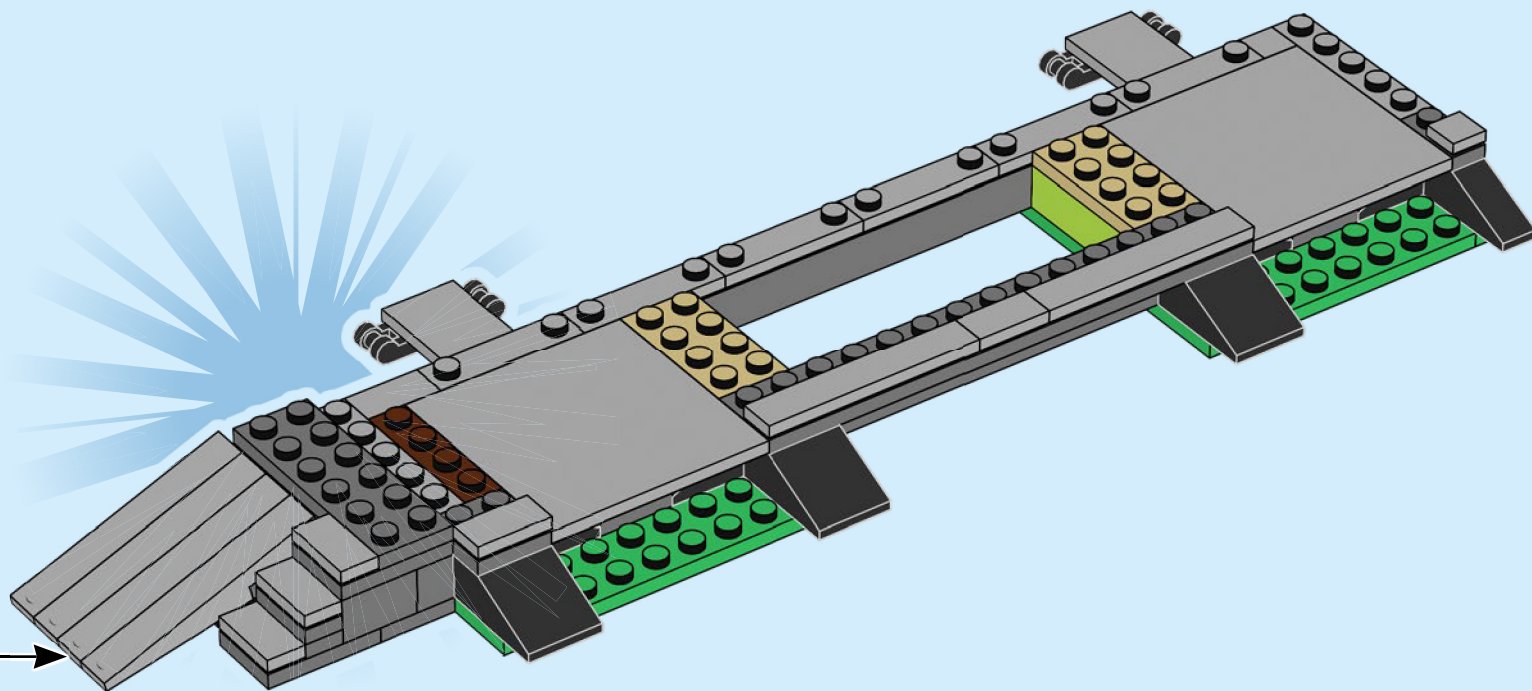

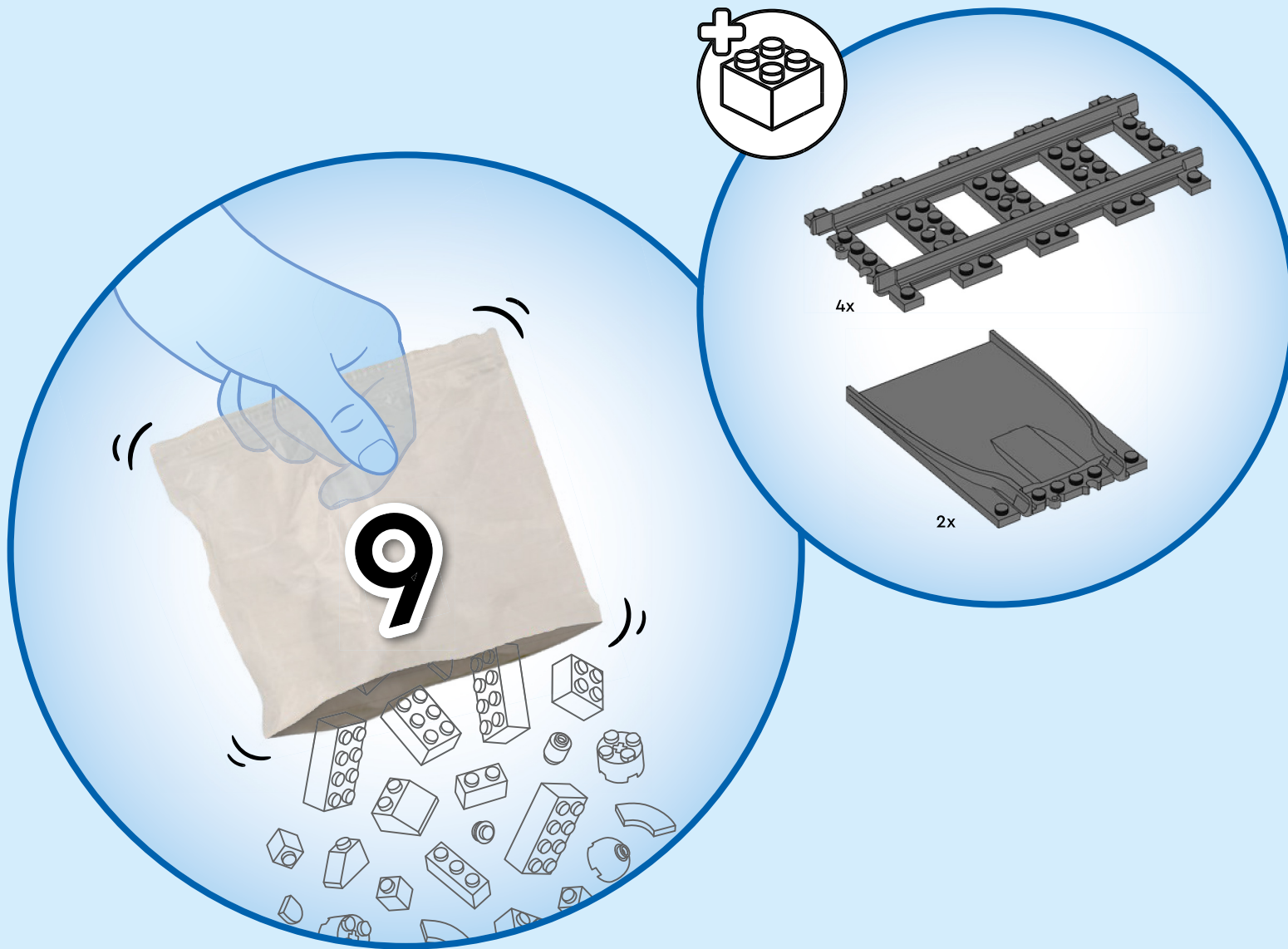

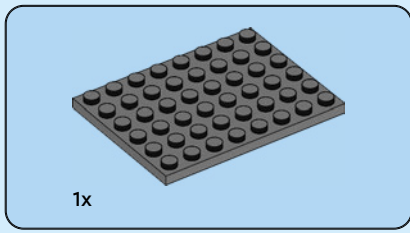

39

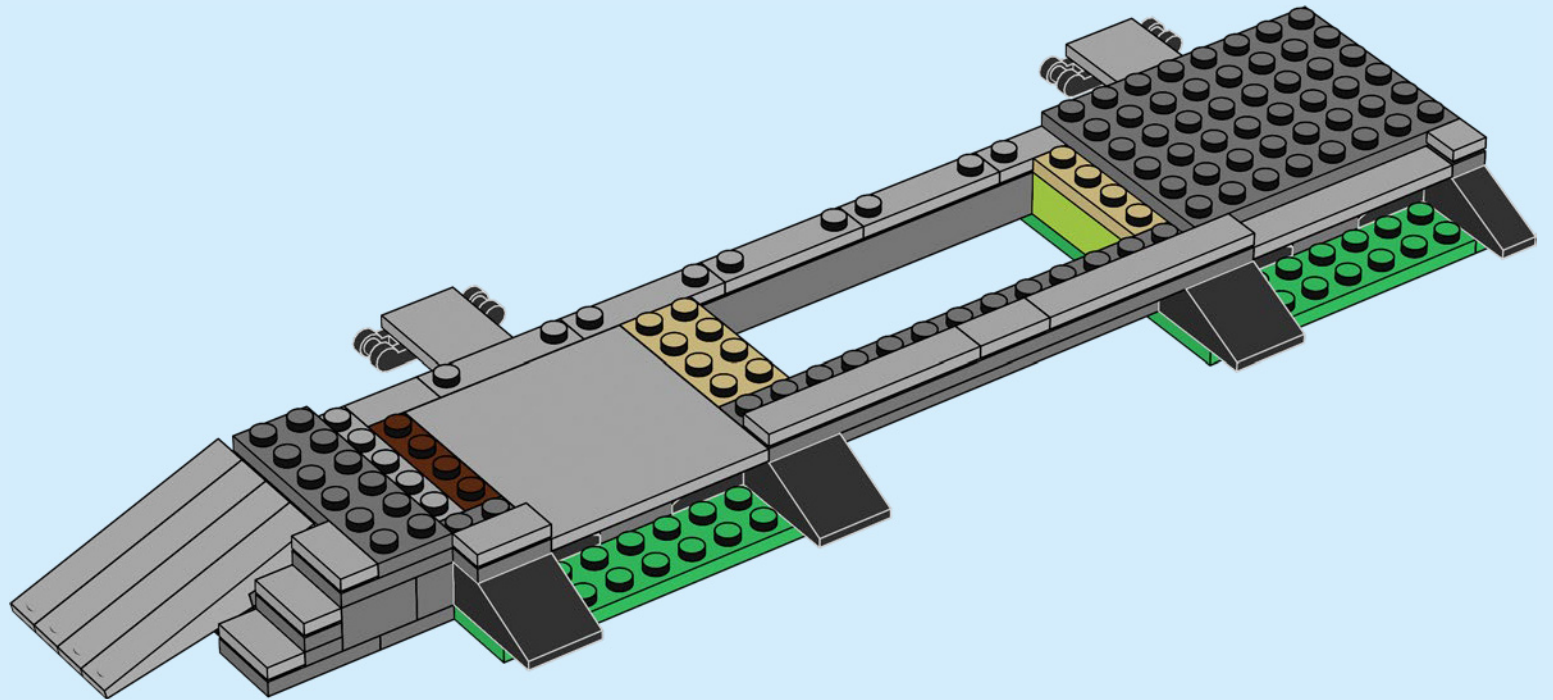

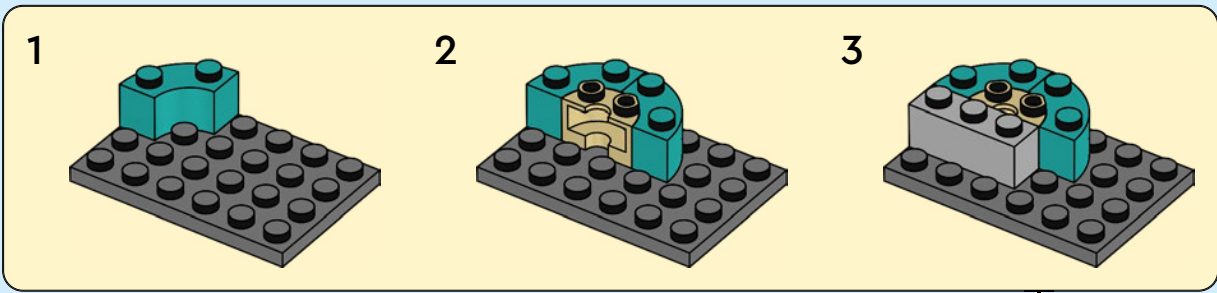
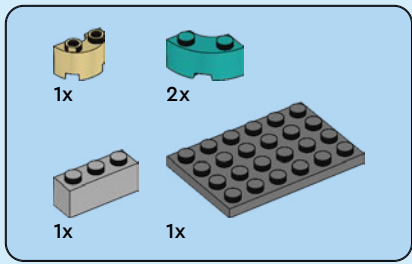

40

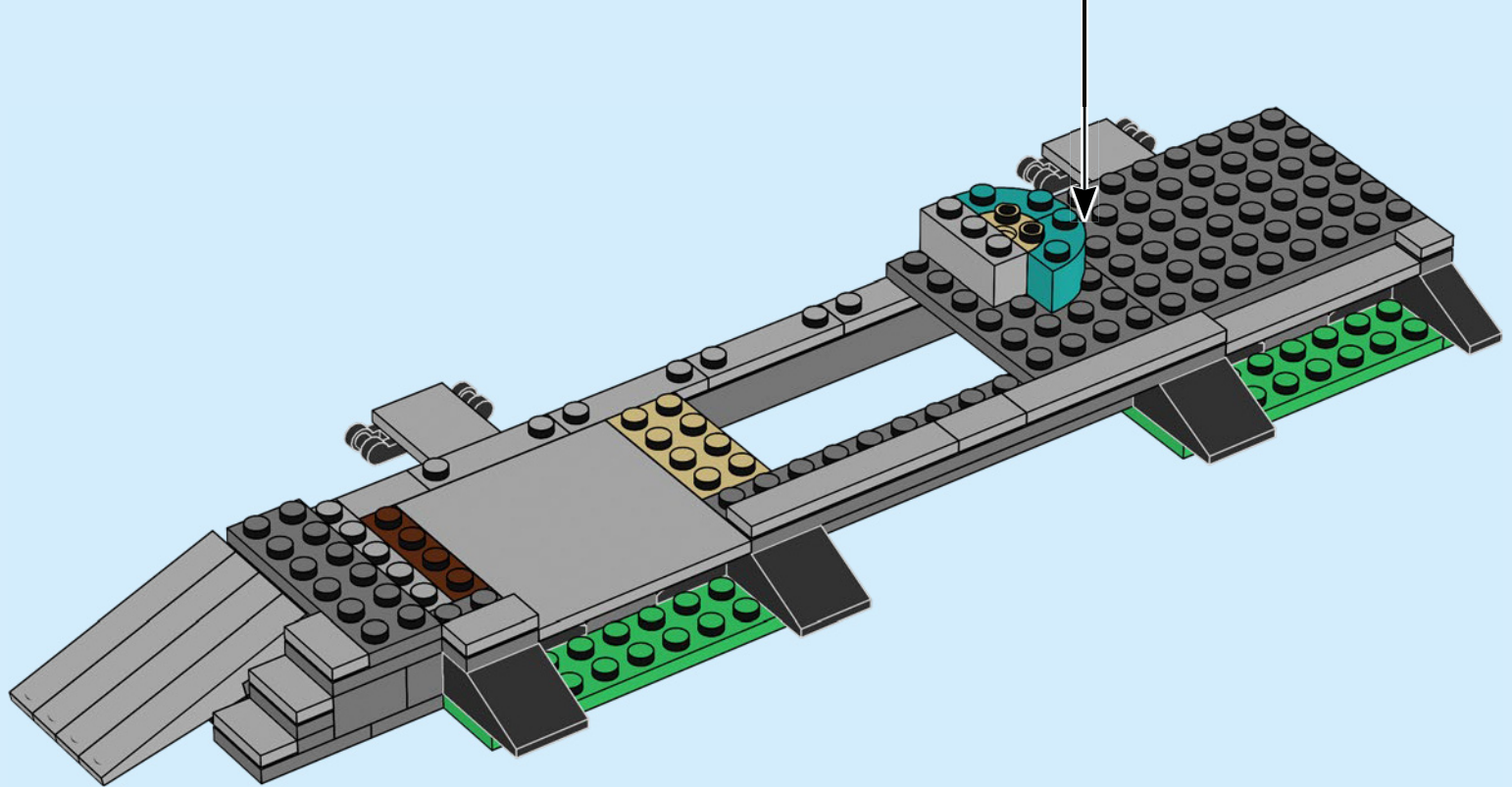

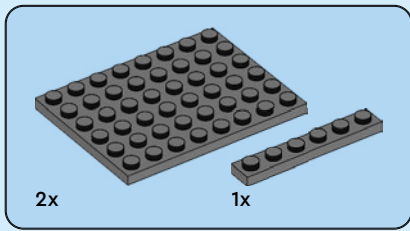

41

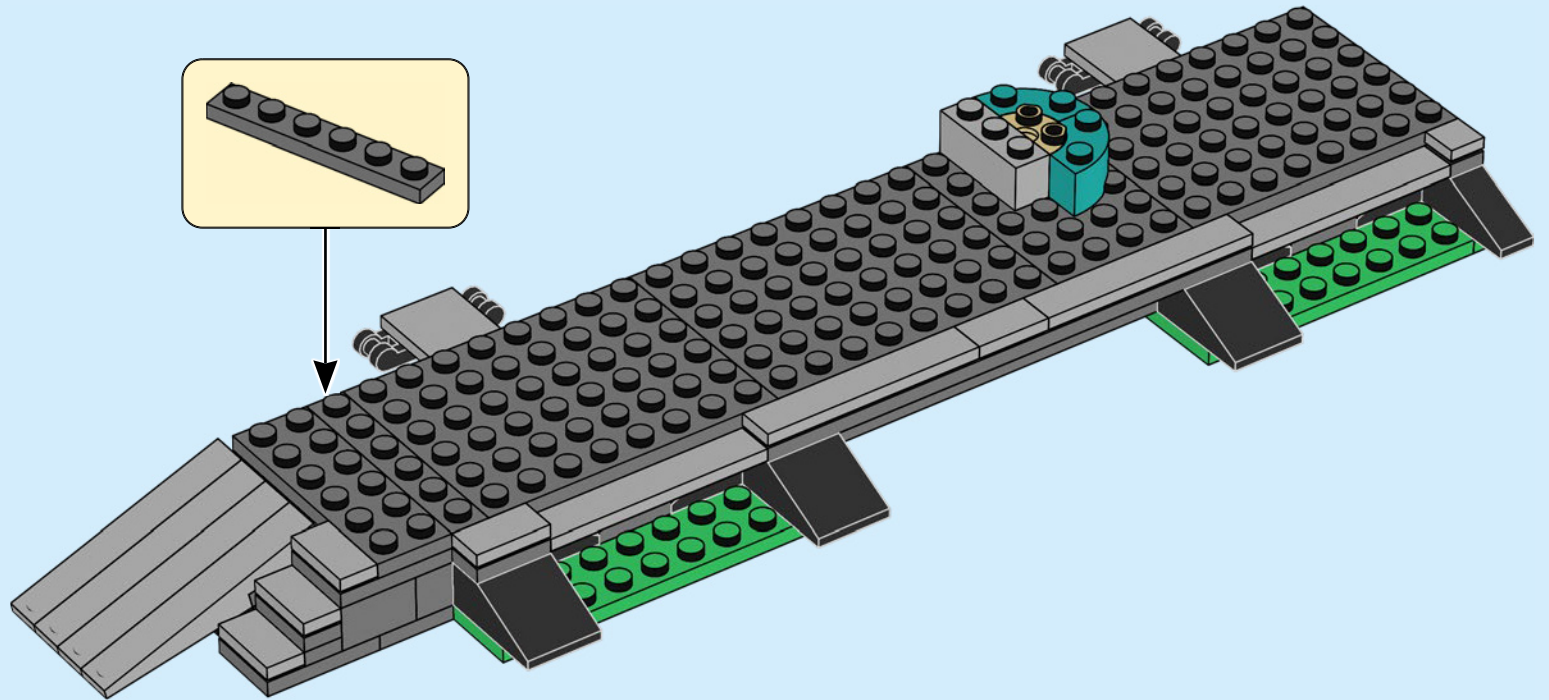

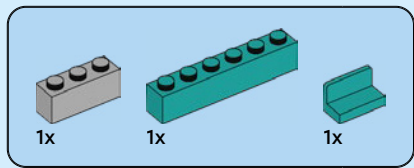

42

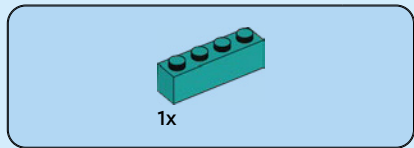
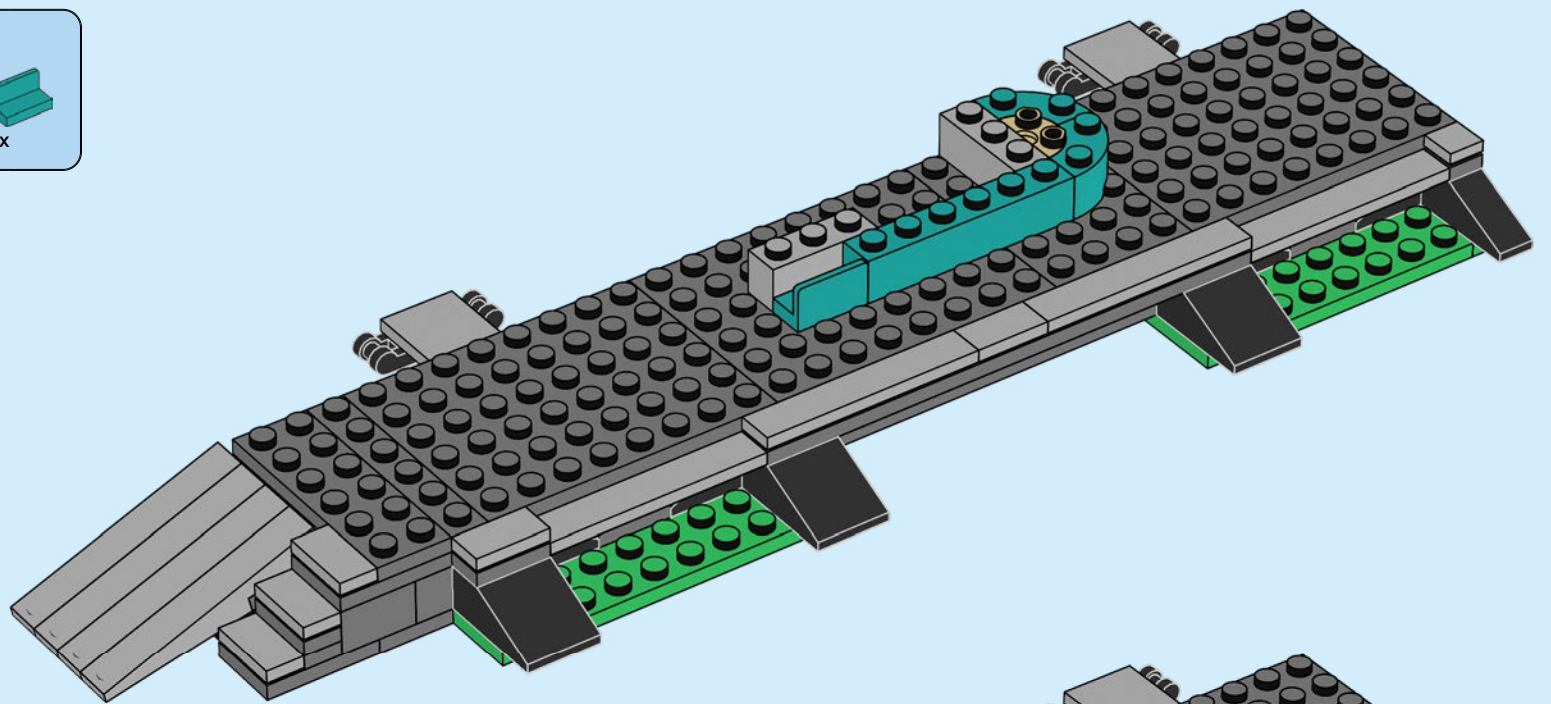

43

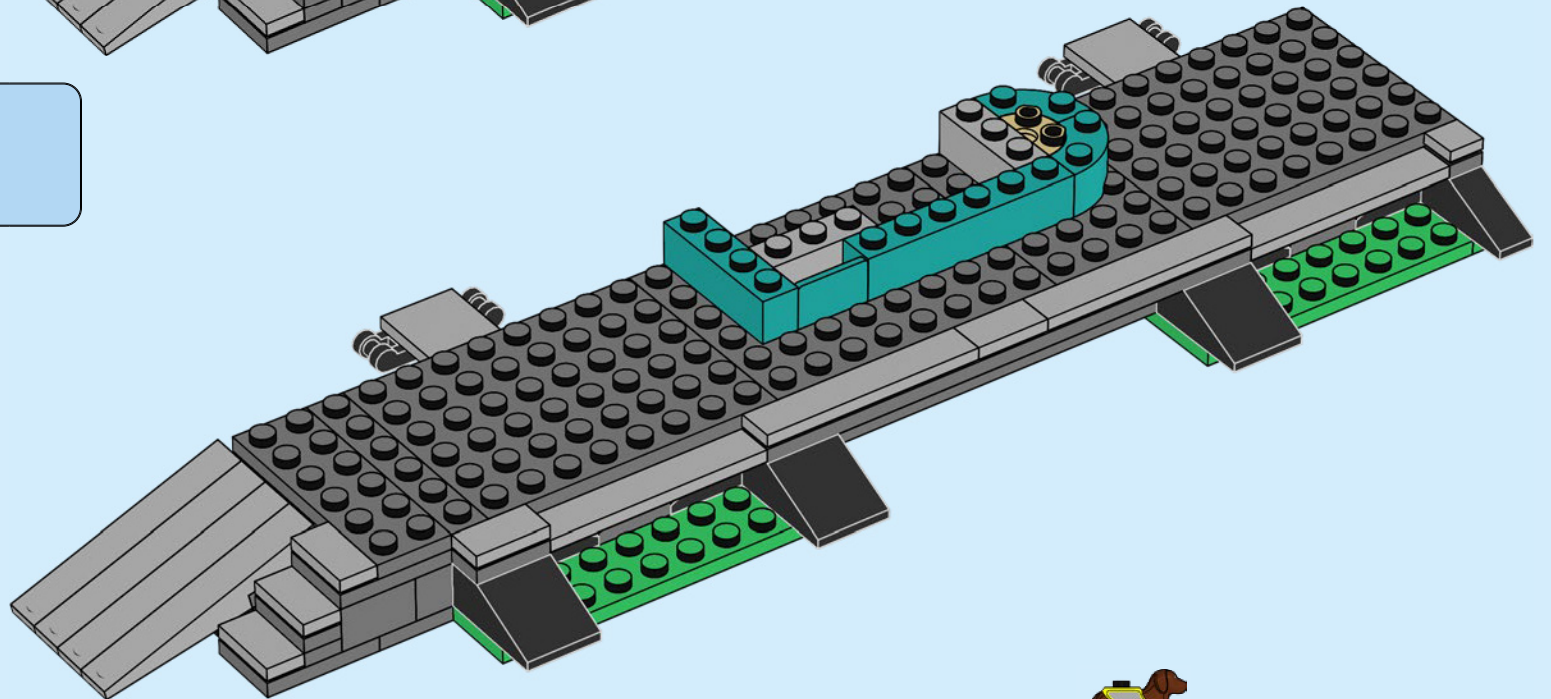

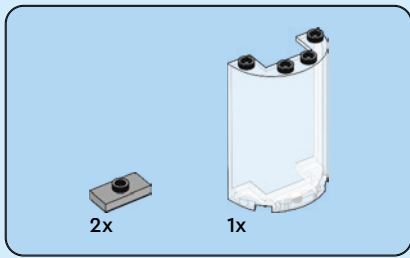

44

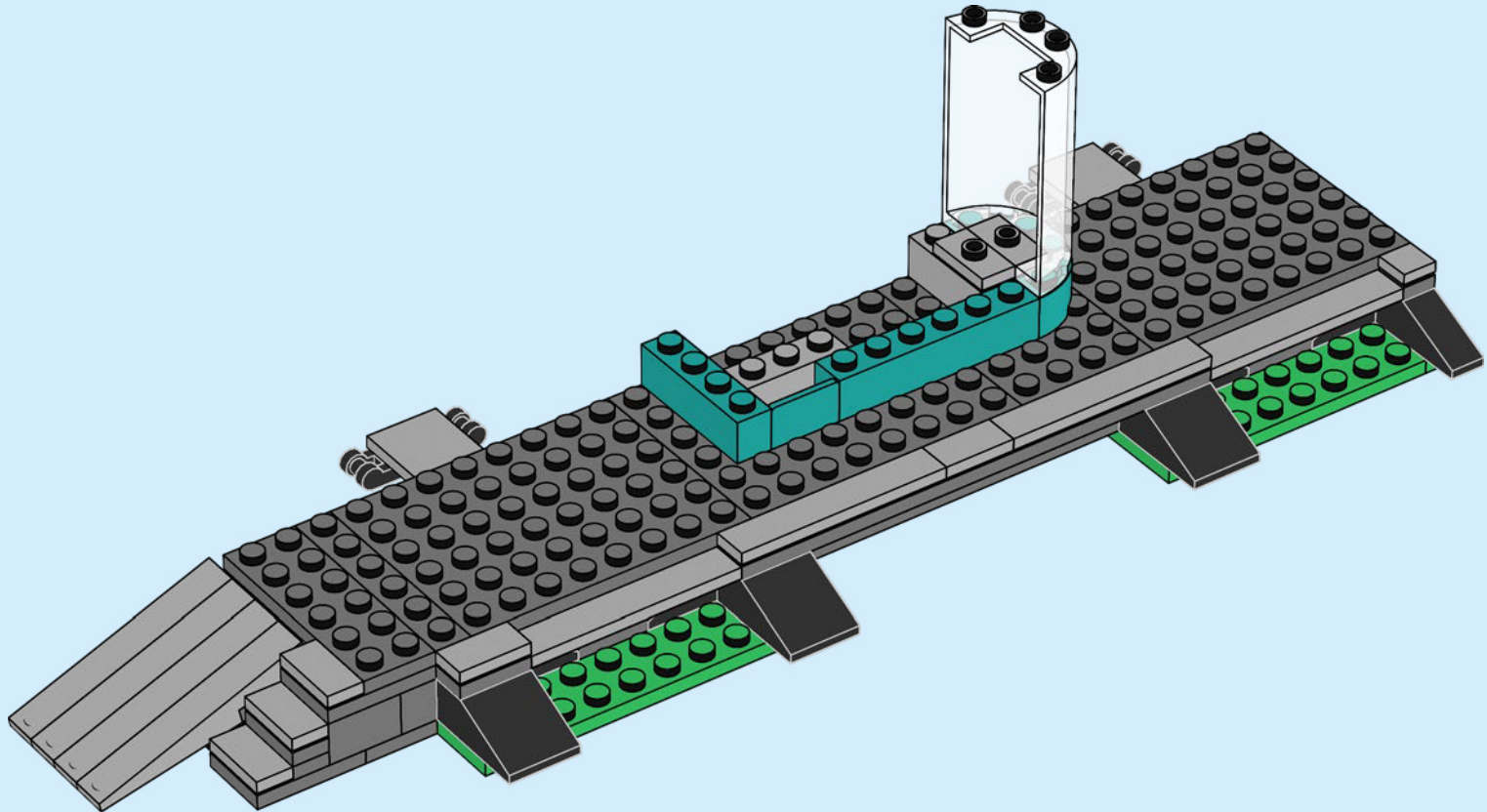

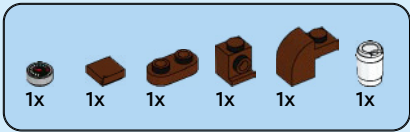

45

1

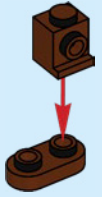

2



3

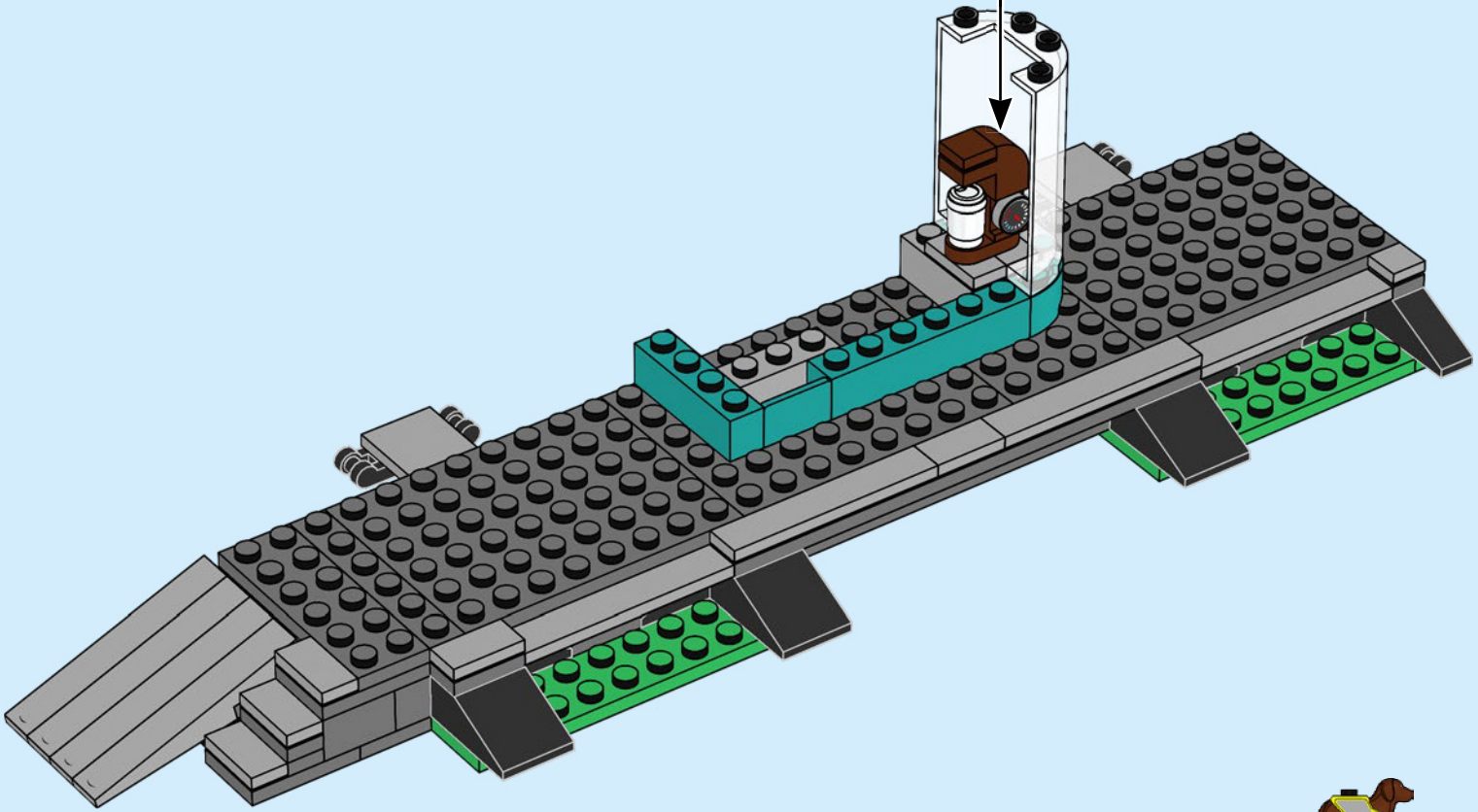
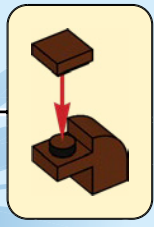

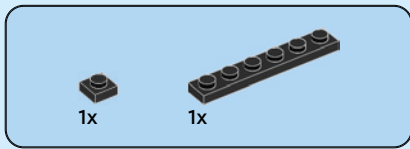

46

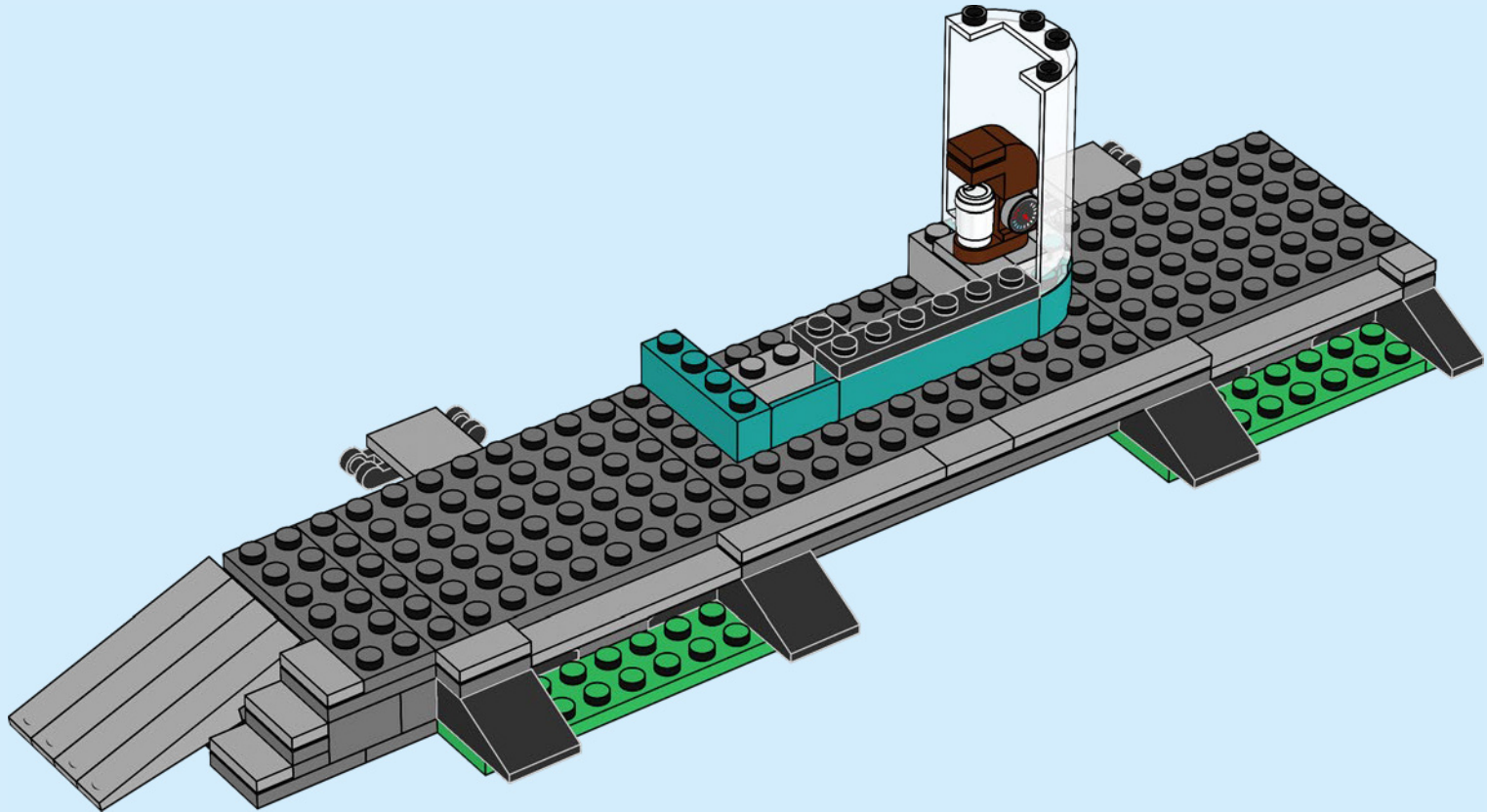



1x

47

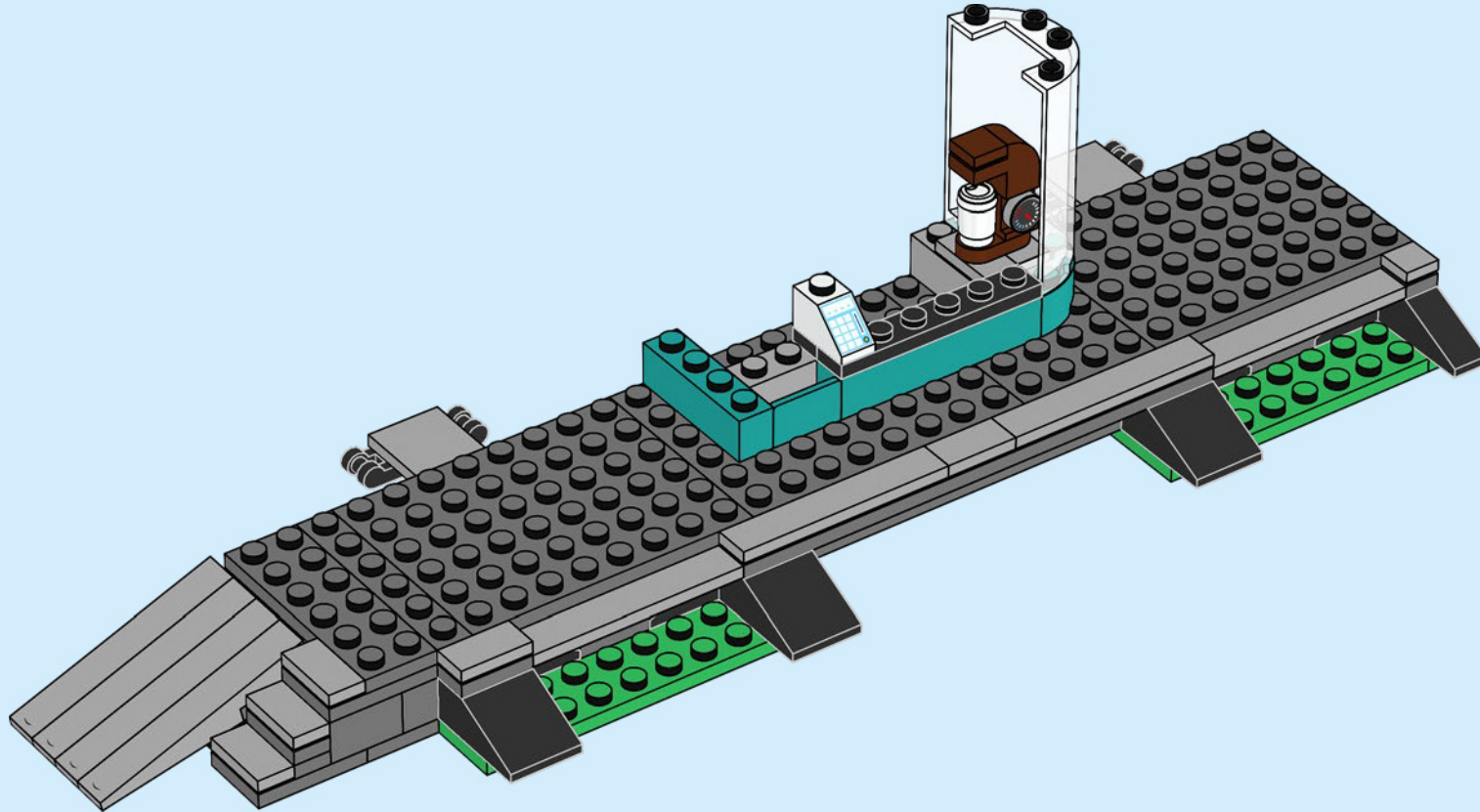

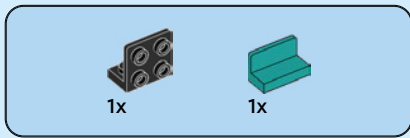

48

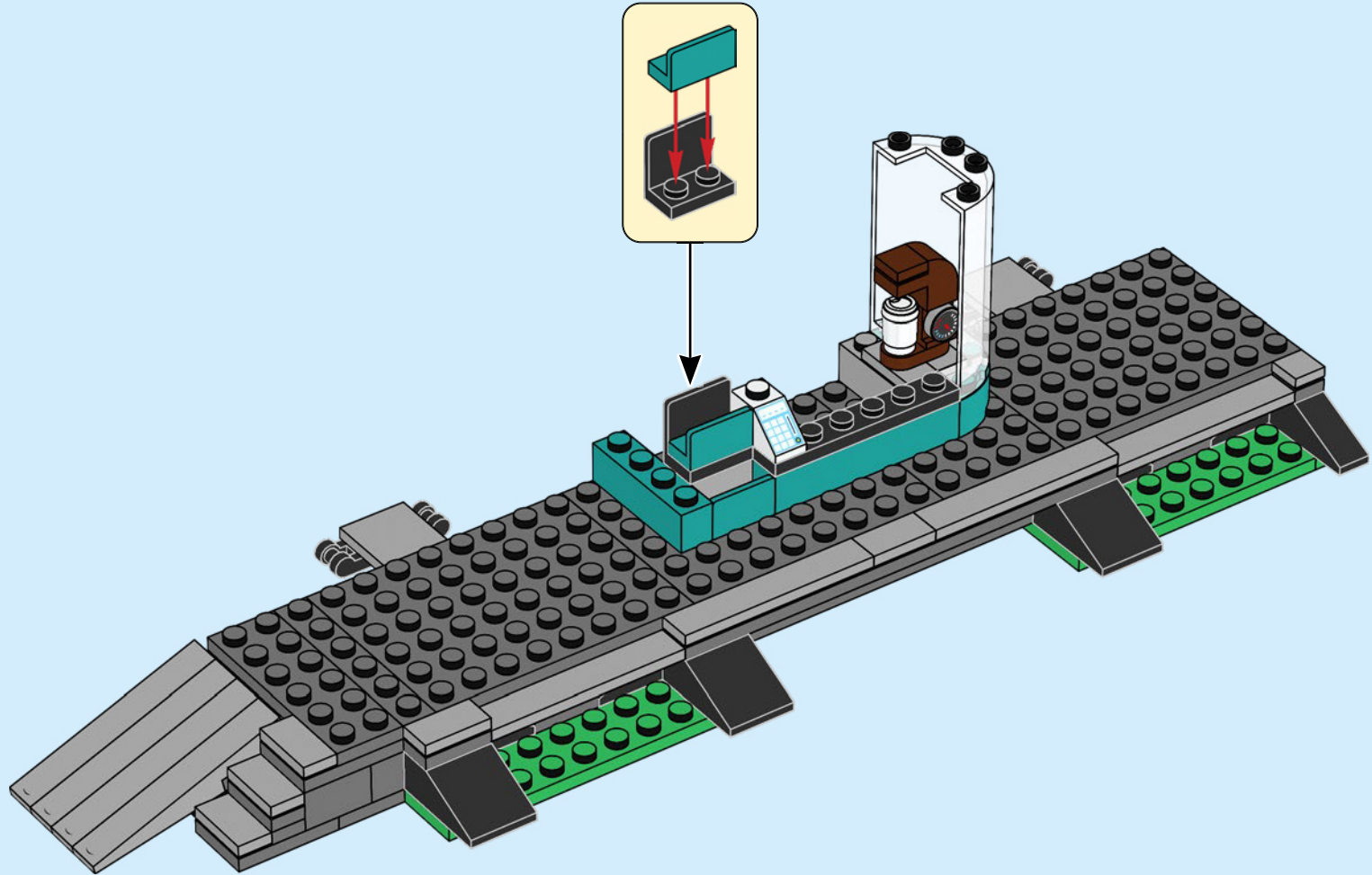



2x

49

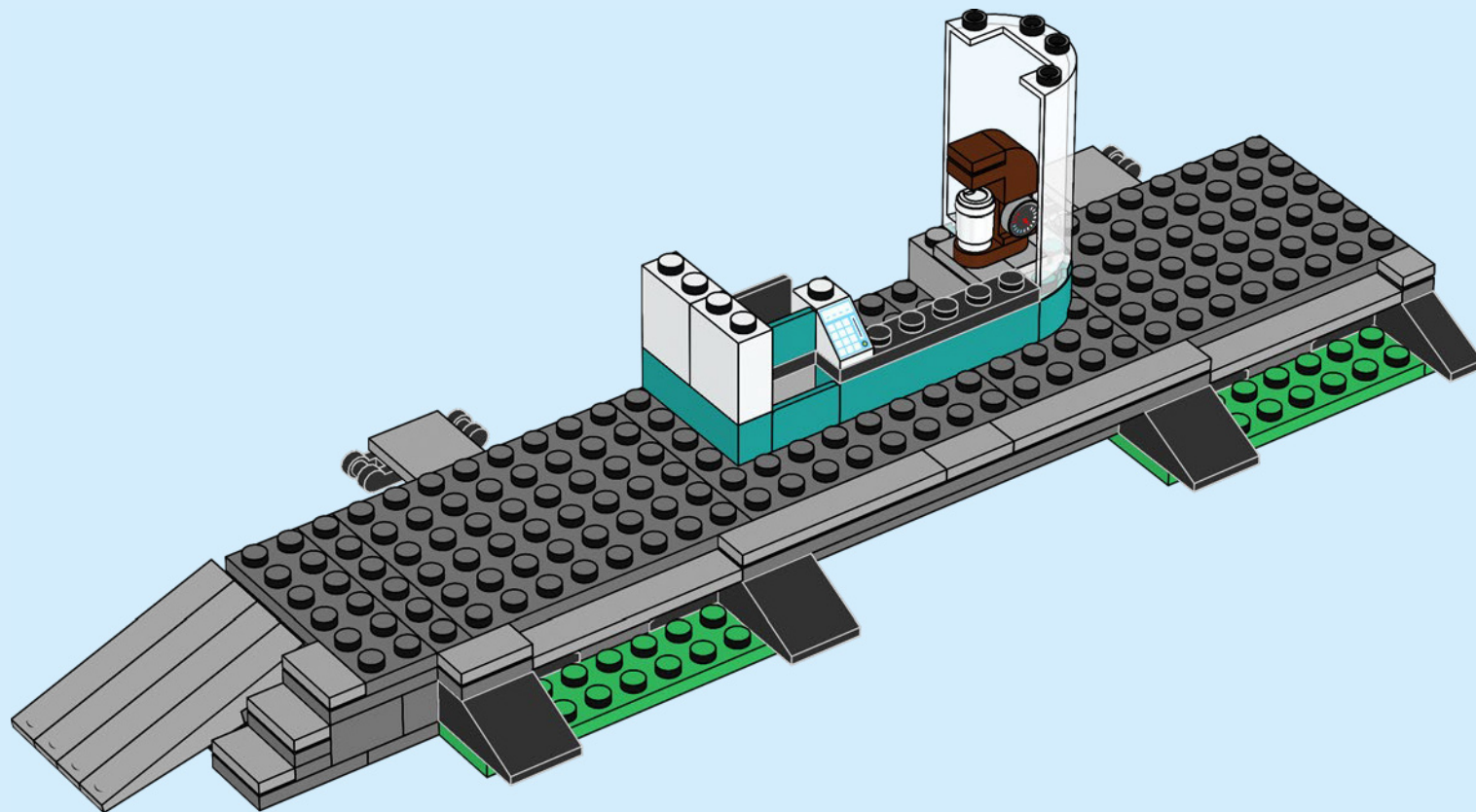



2x

50

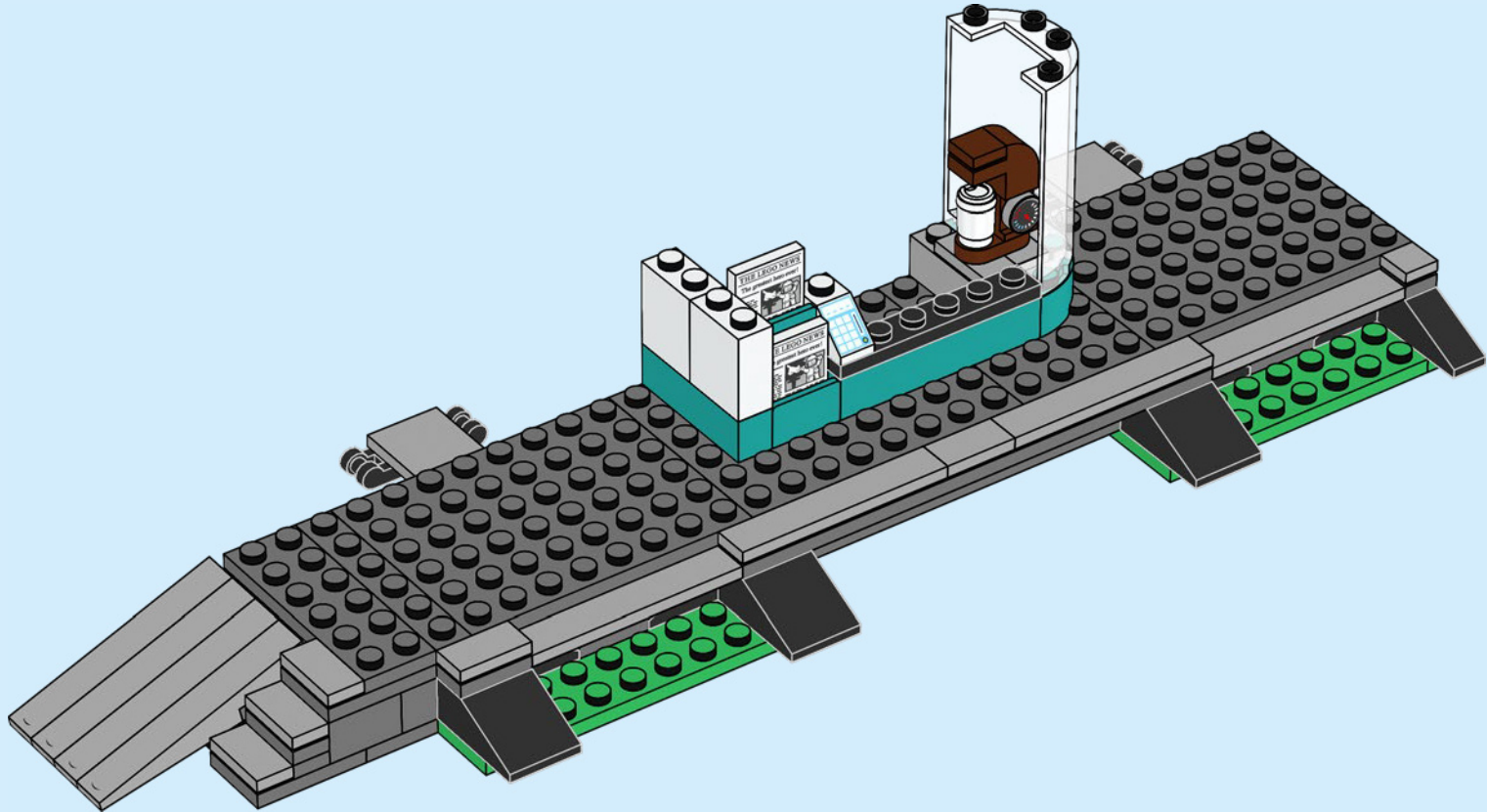

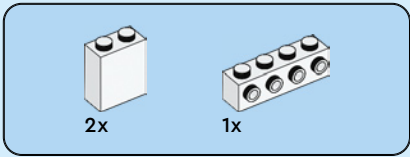

51

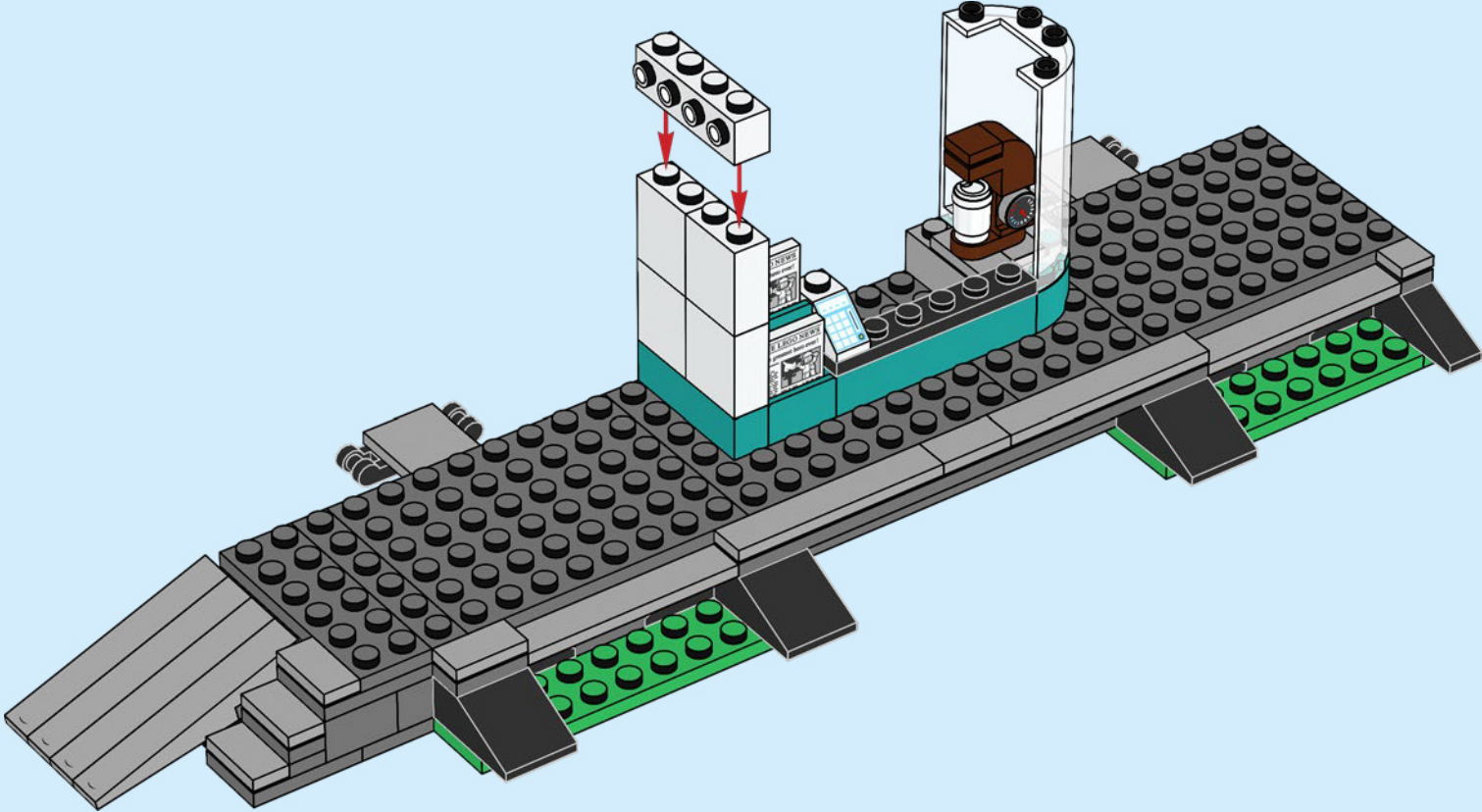

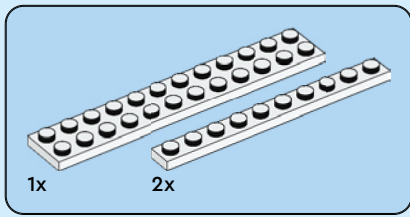

52

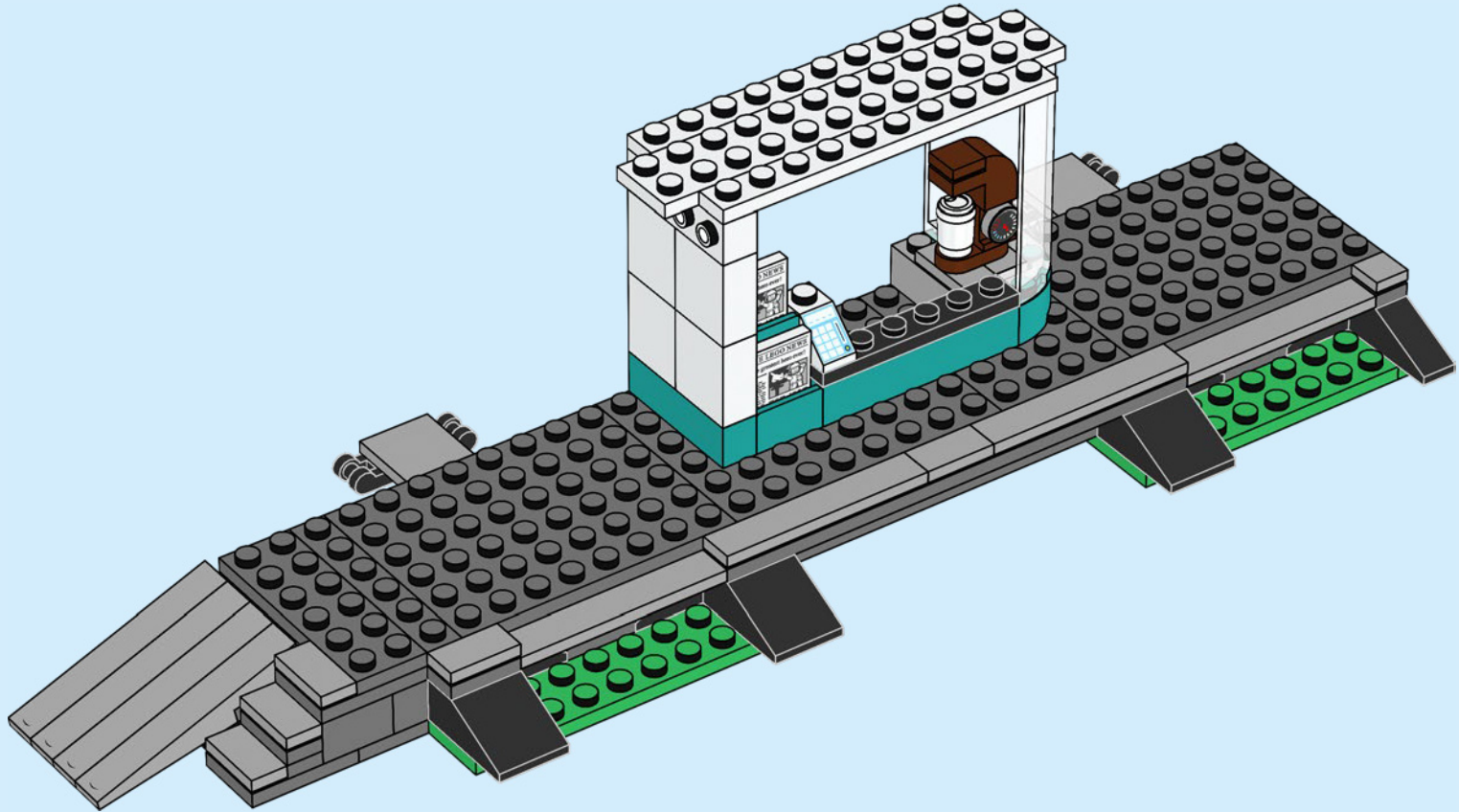

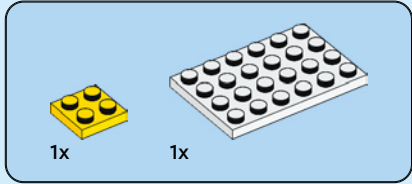

53

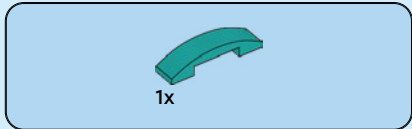
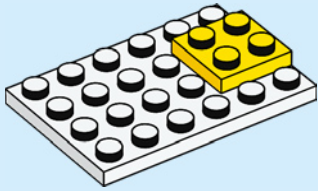

54

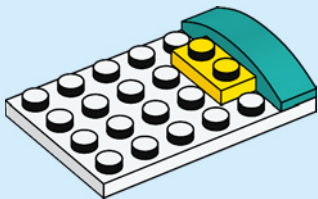

55

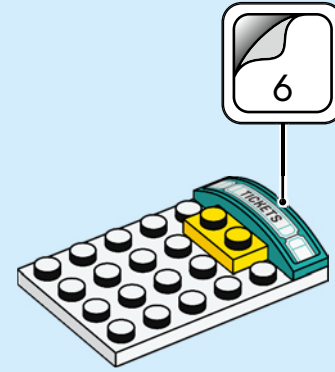

56

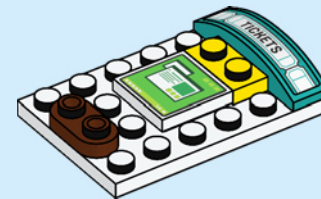

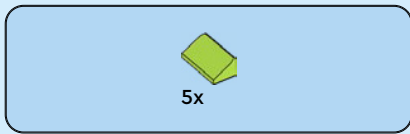

57

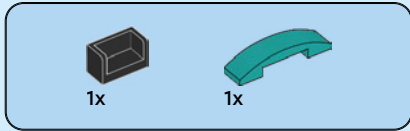
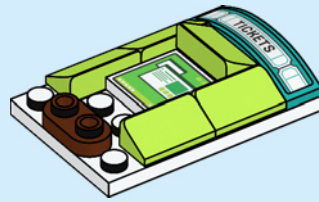

58

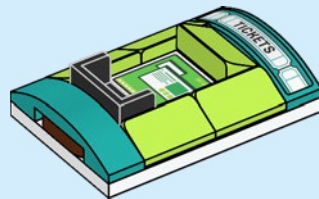

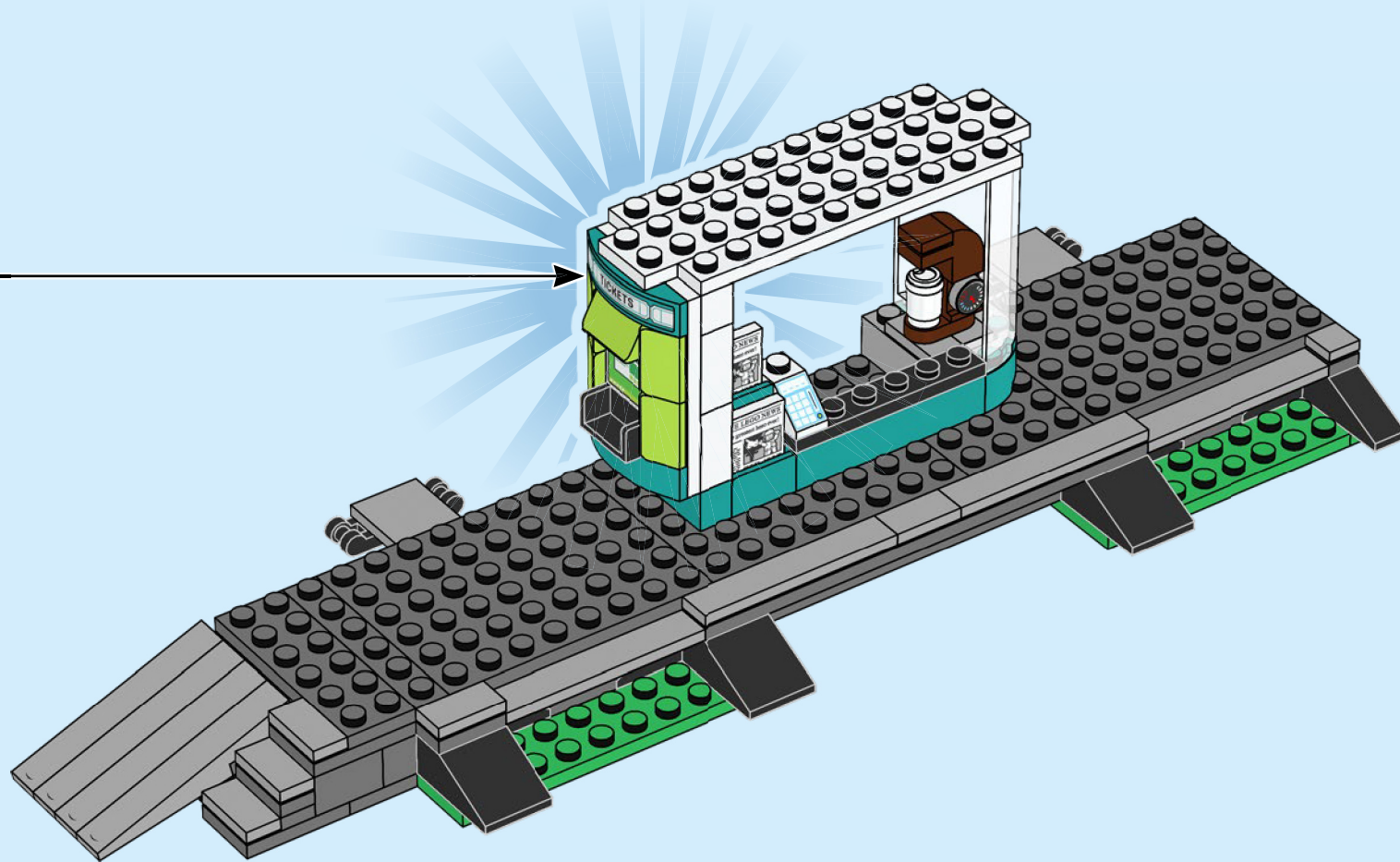

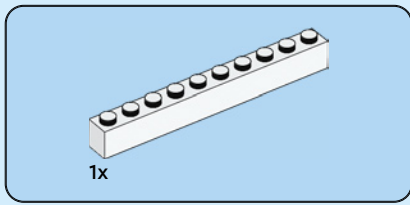

60

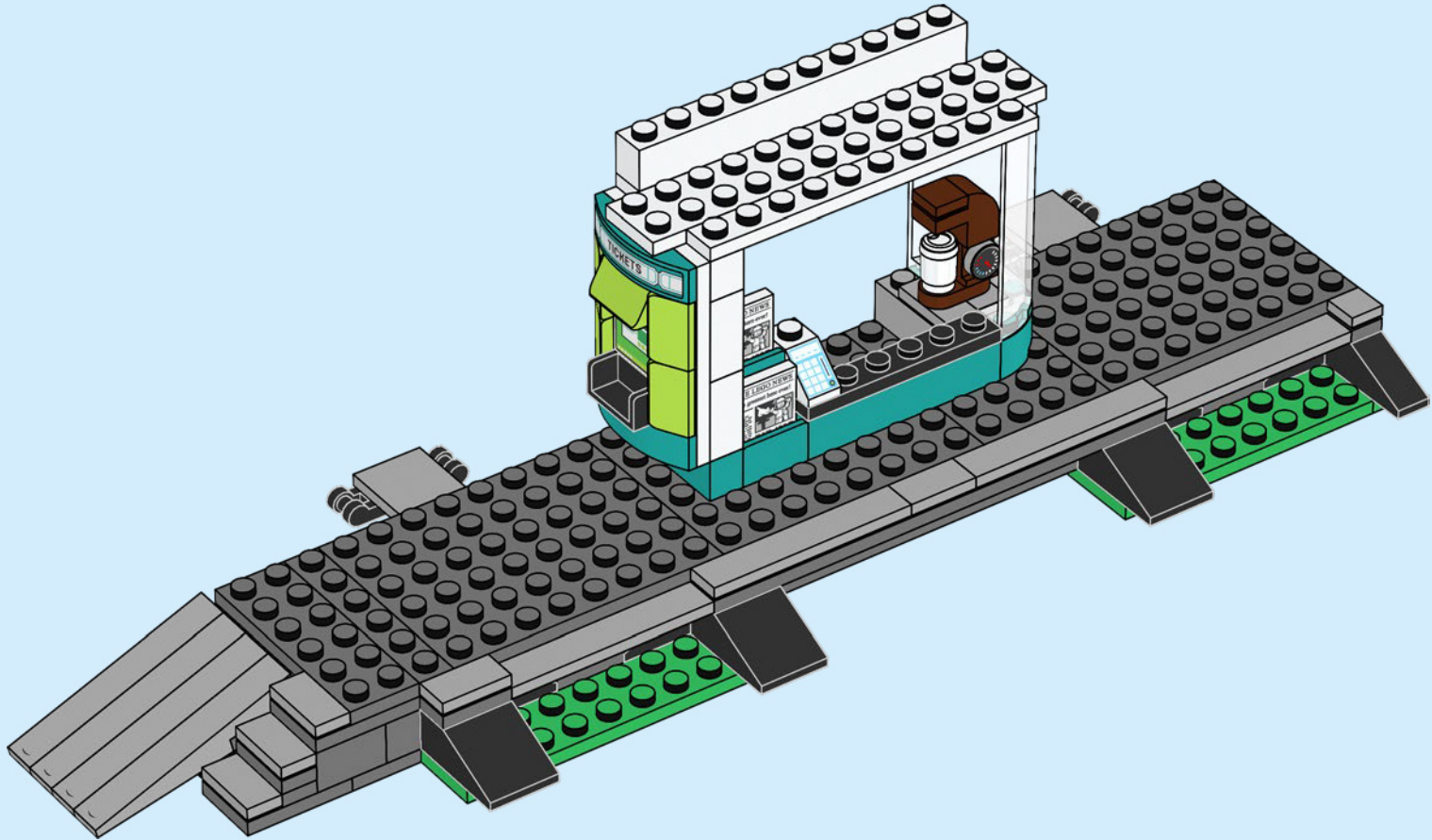



2x

61

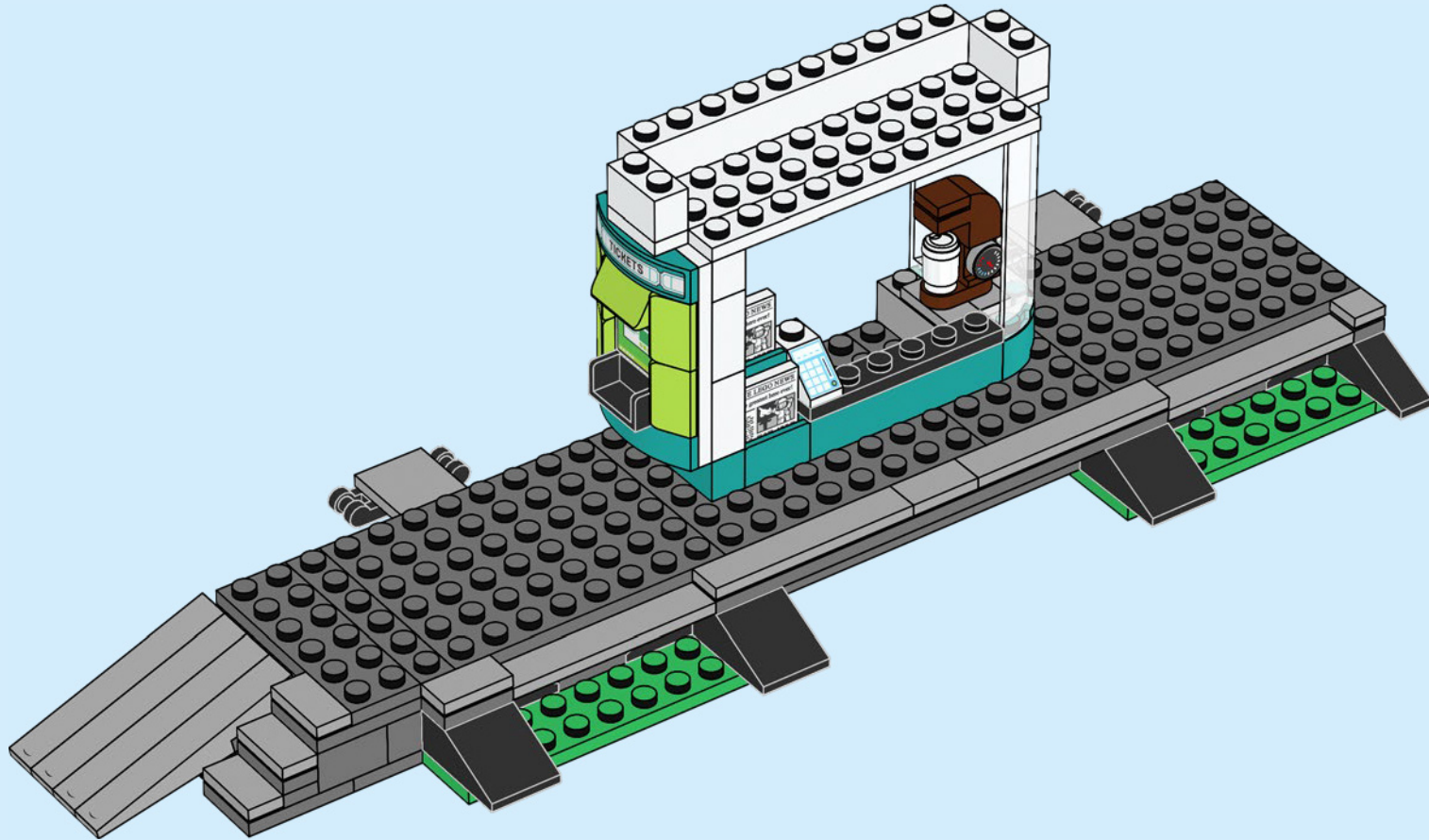

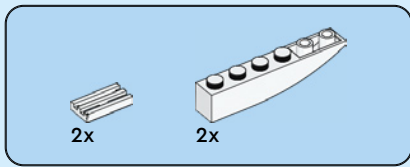

62

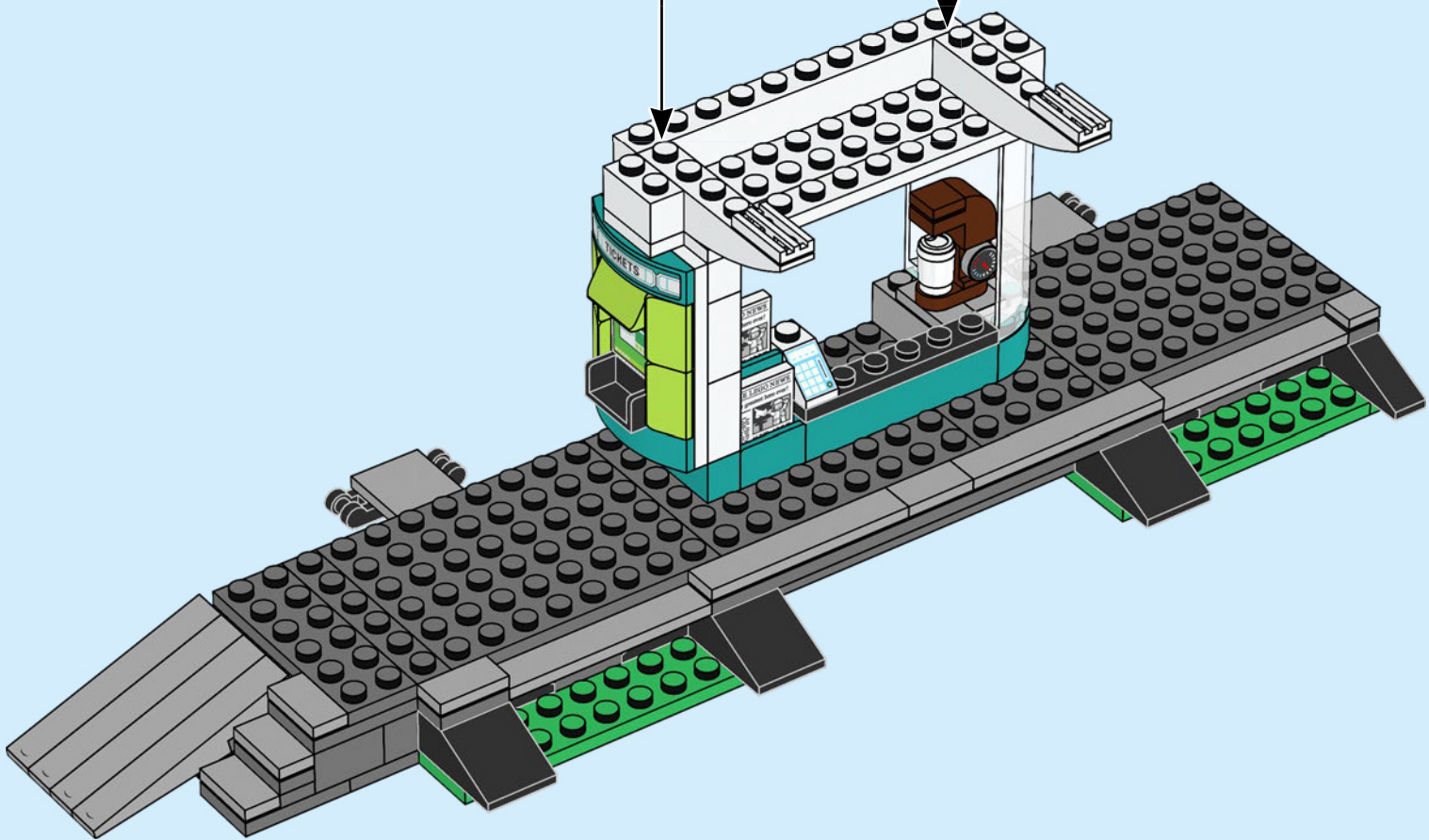
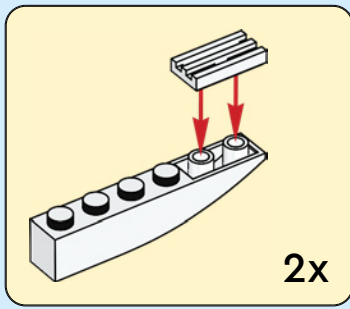



2x

63

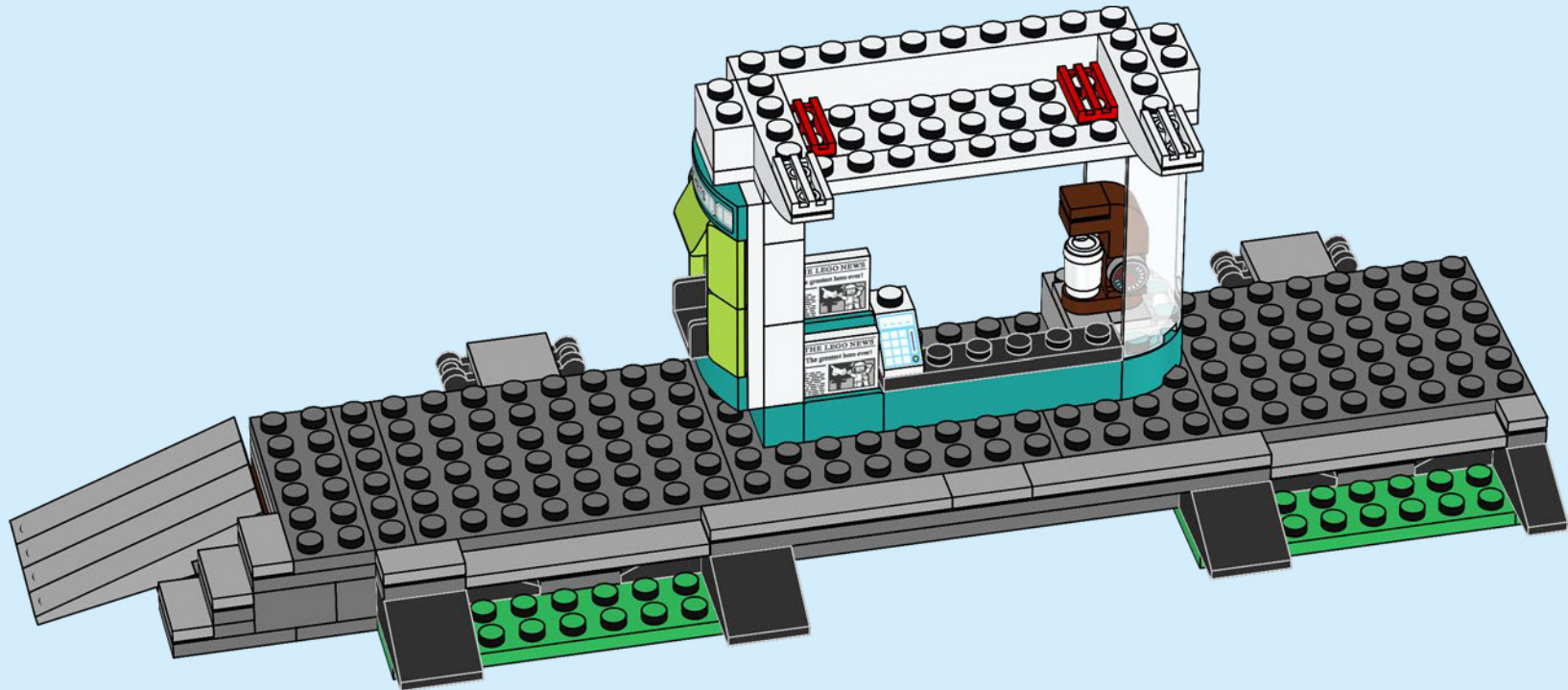

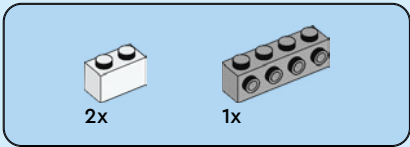

64

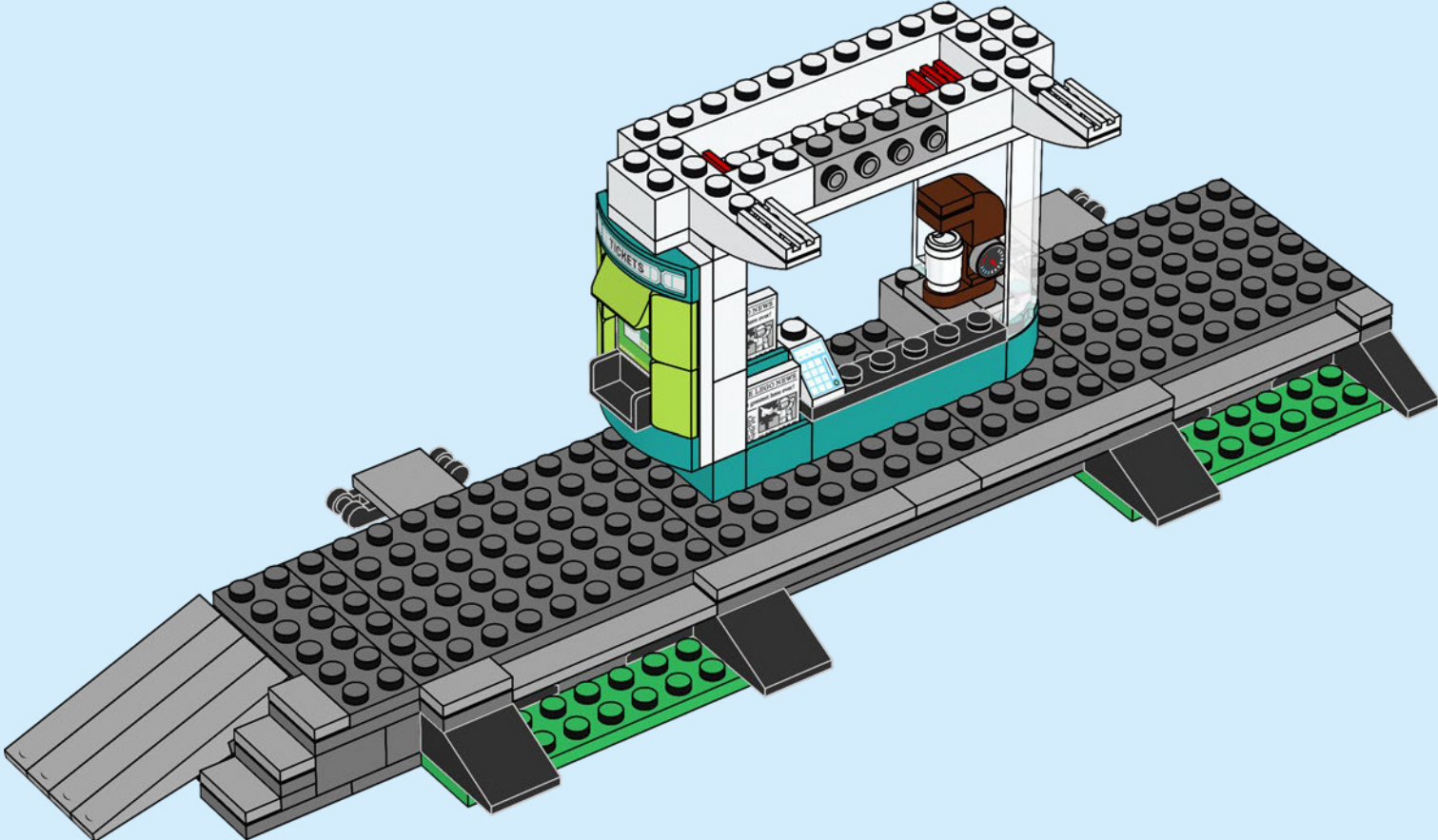

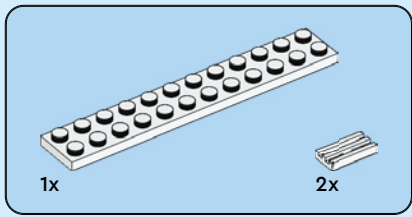

65

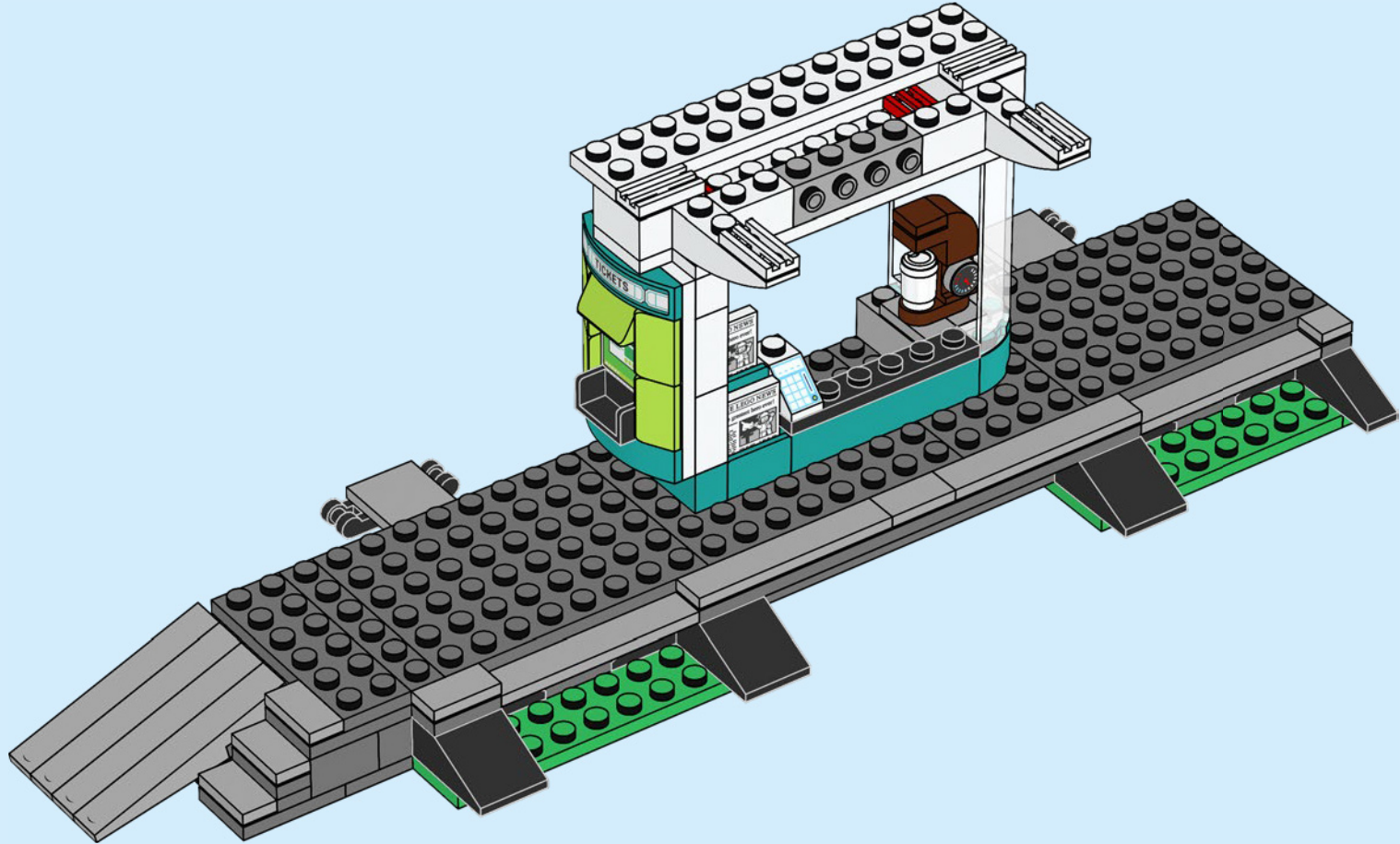

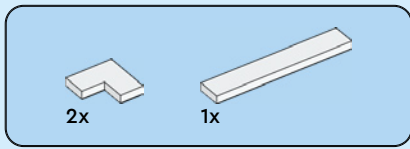

66

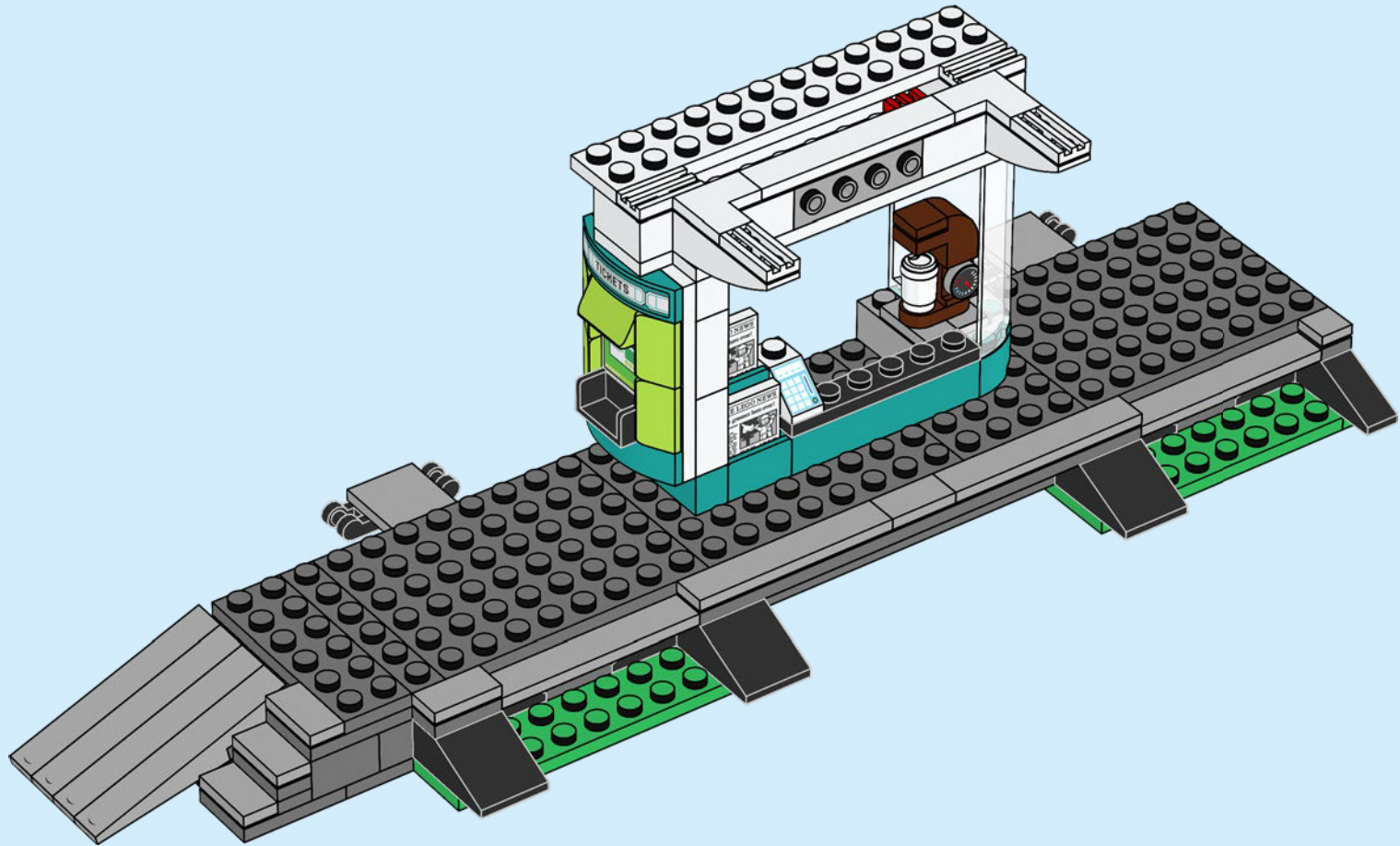

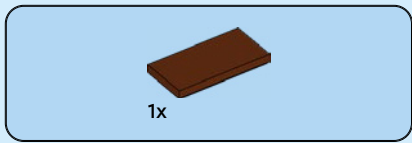

67

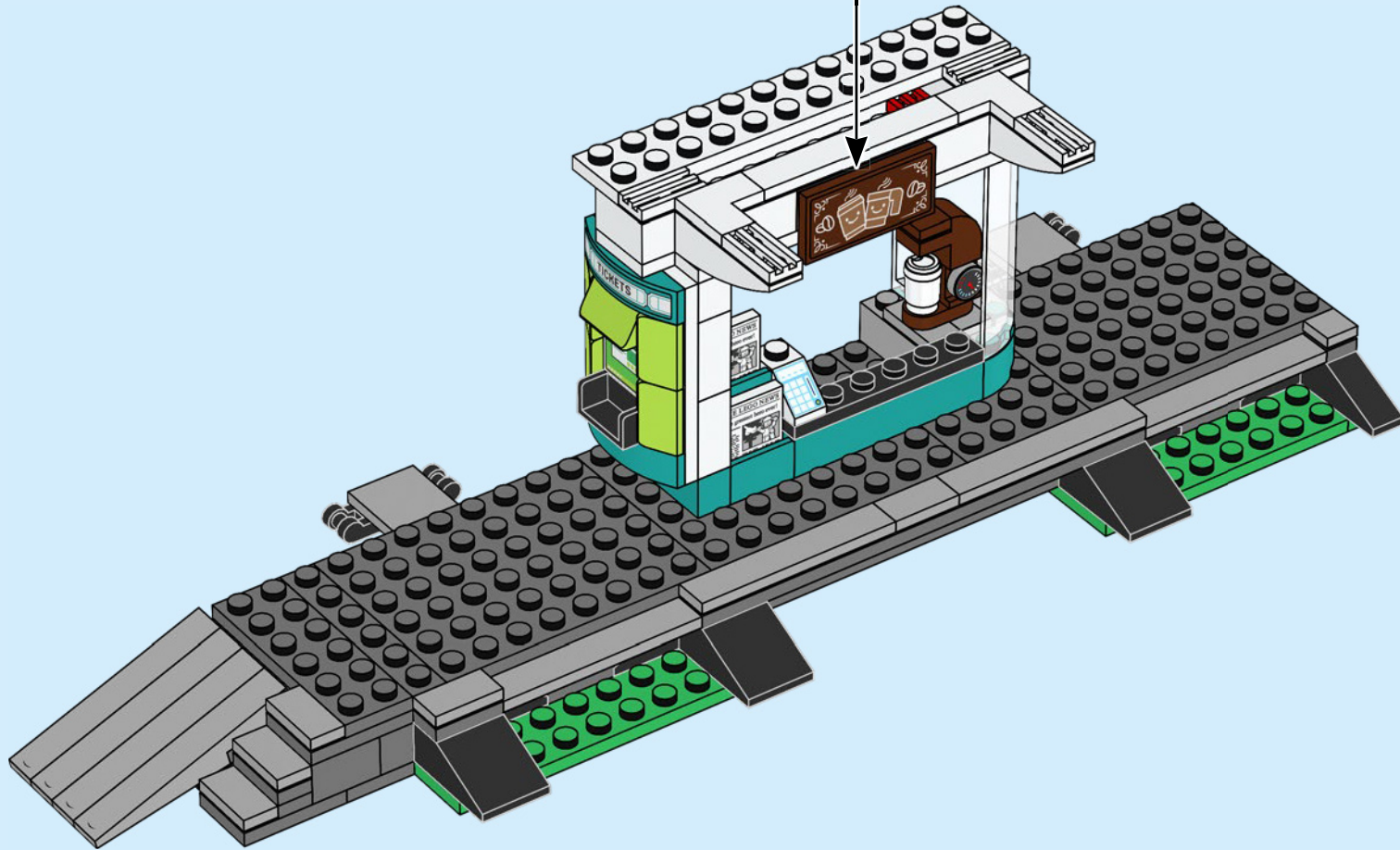
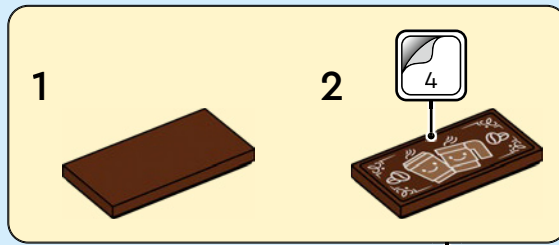



2x

68

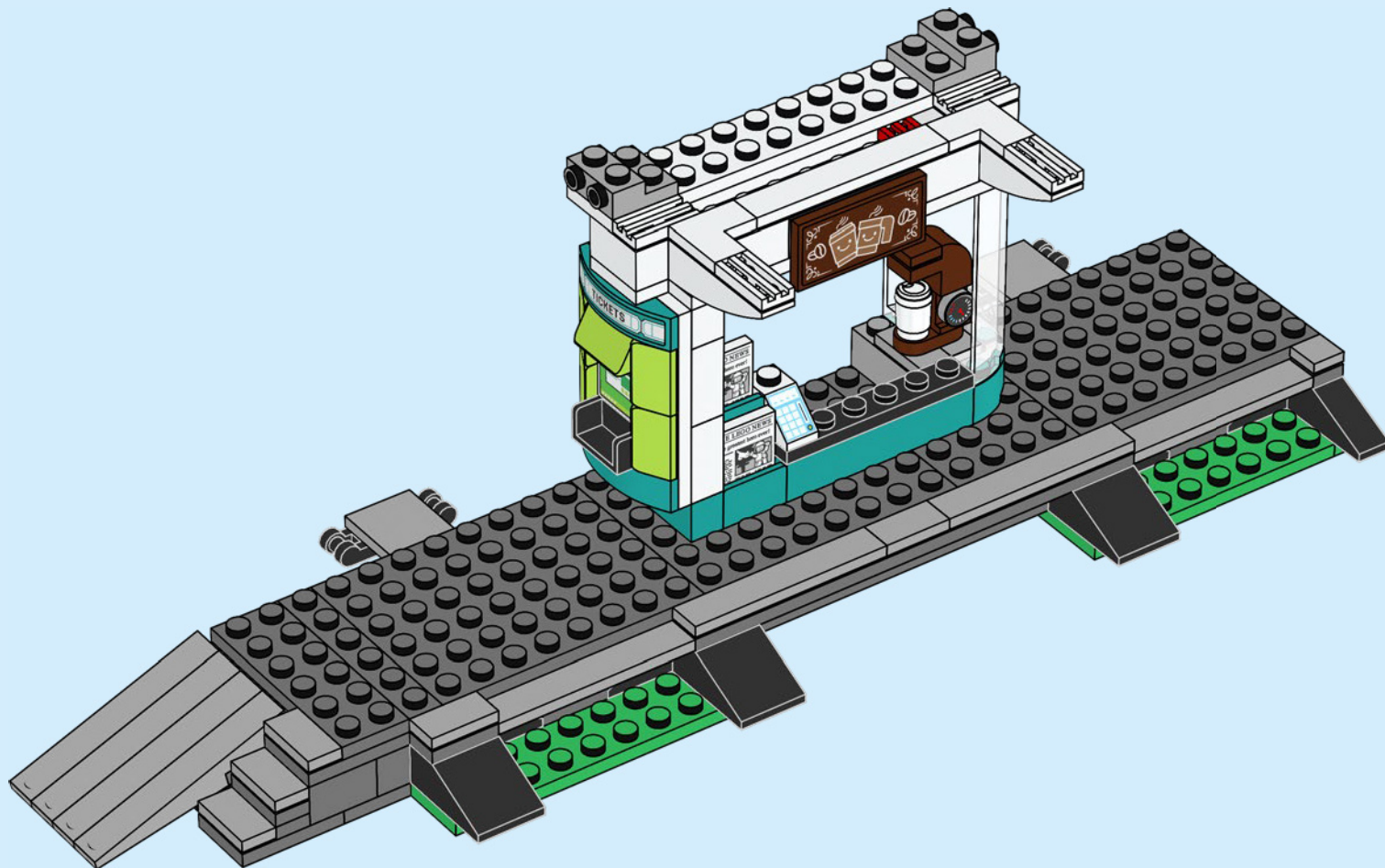



2x



3x

69

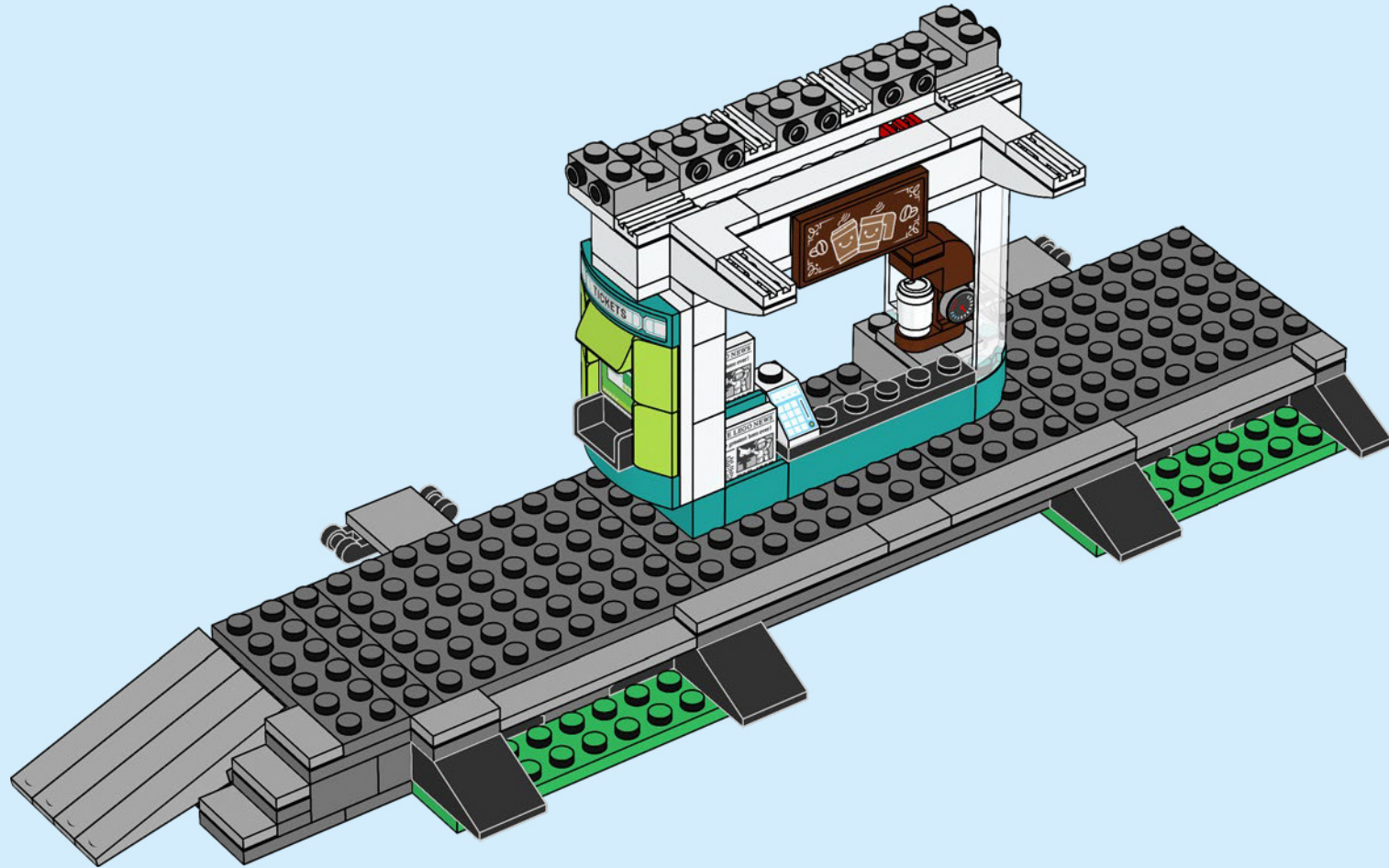

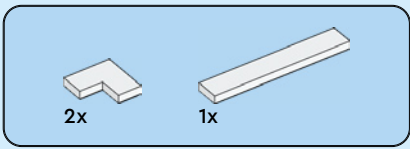

70

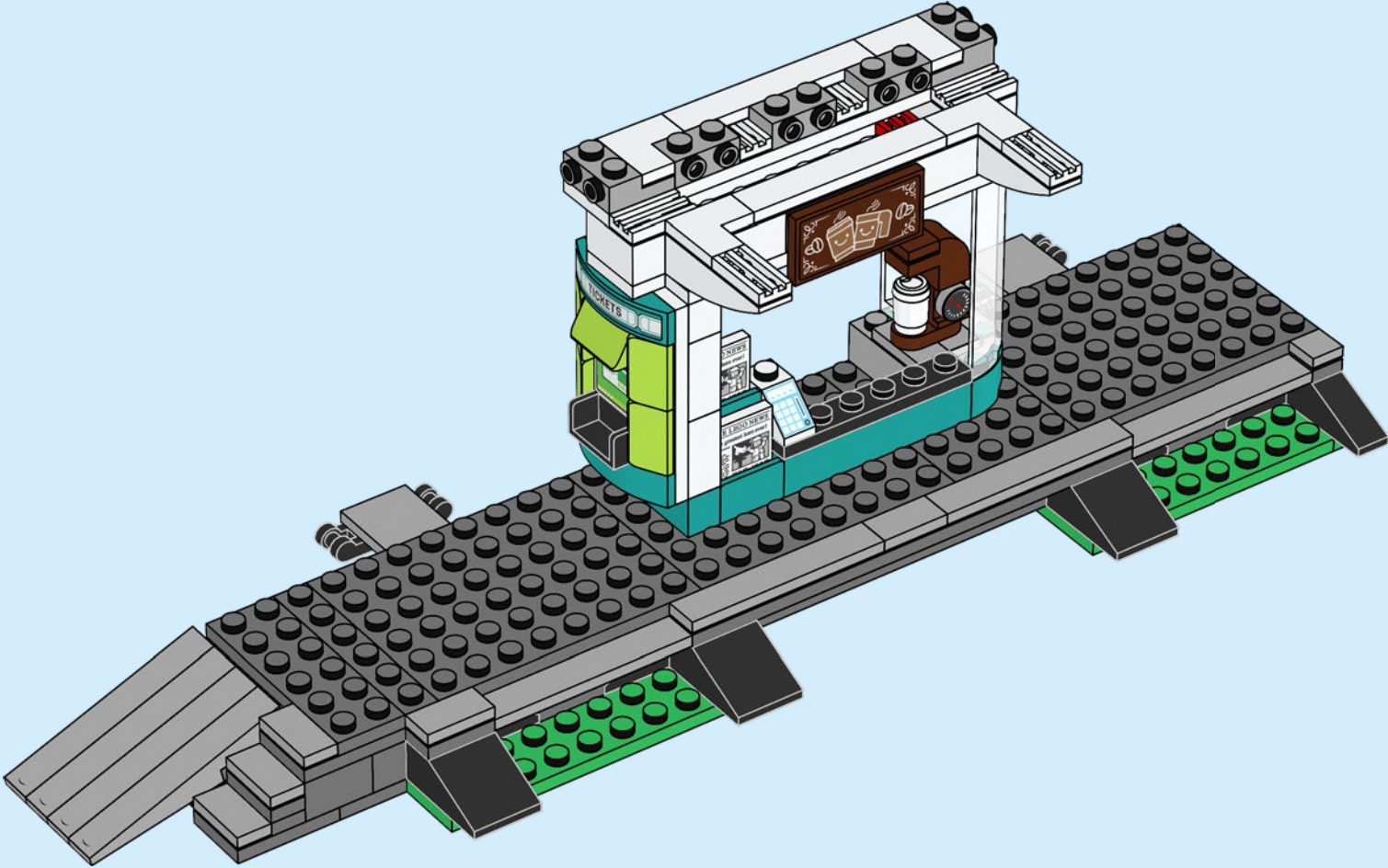

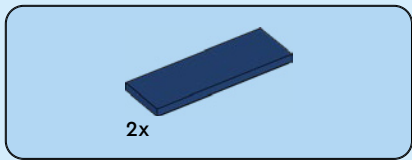

71

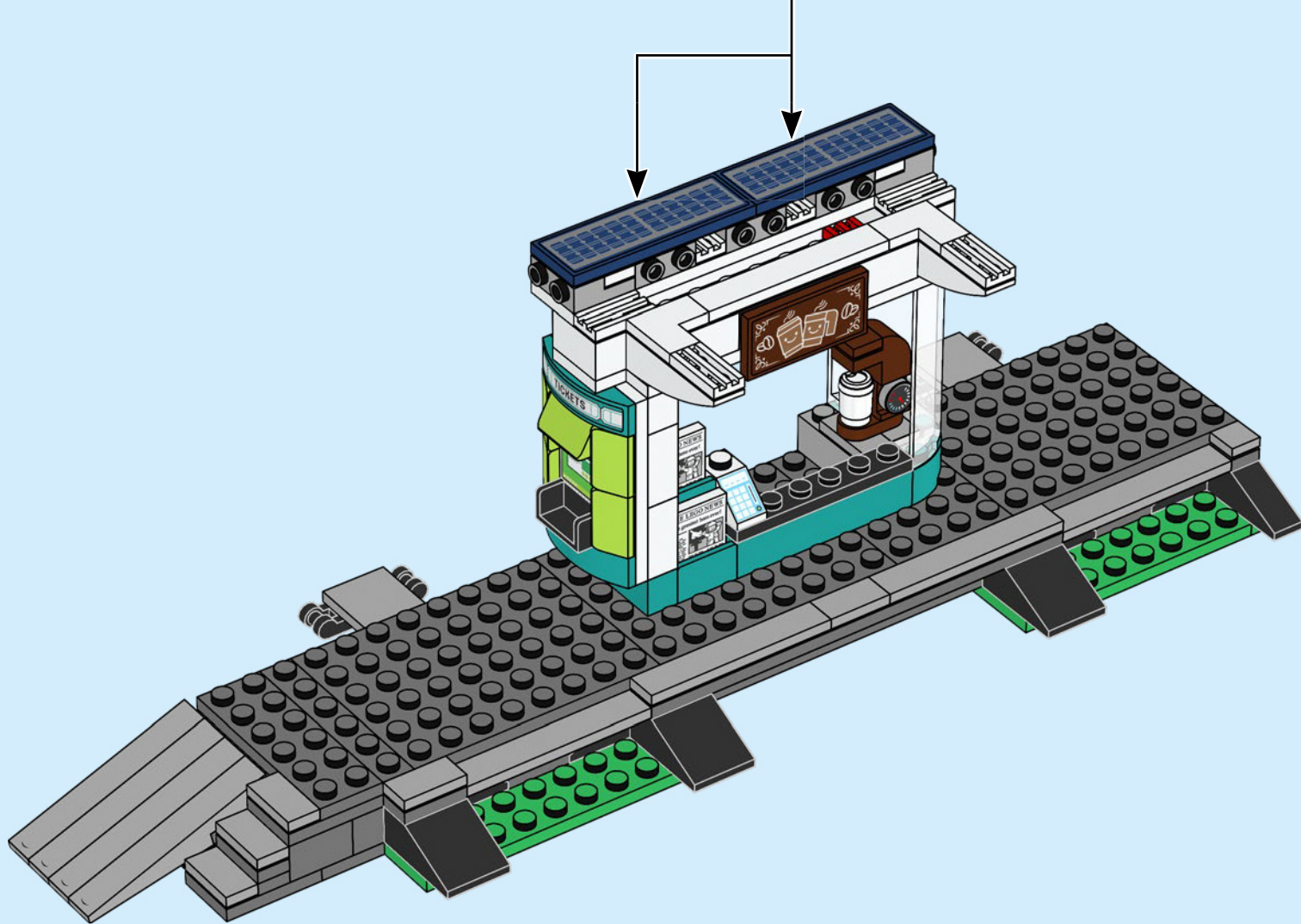
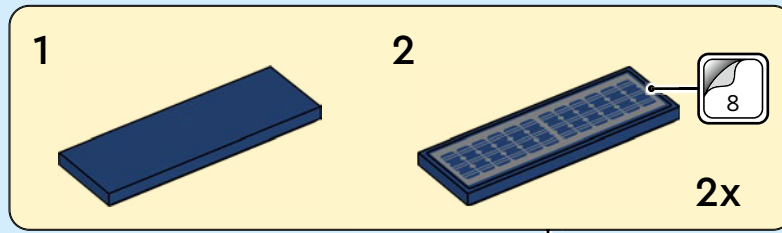

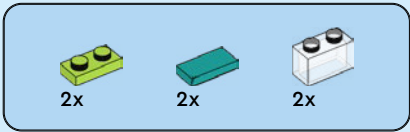

72

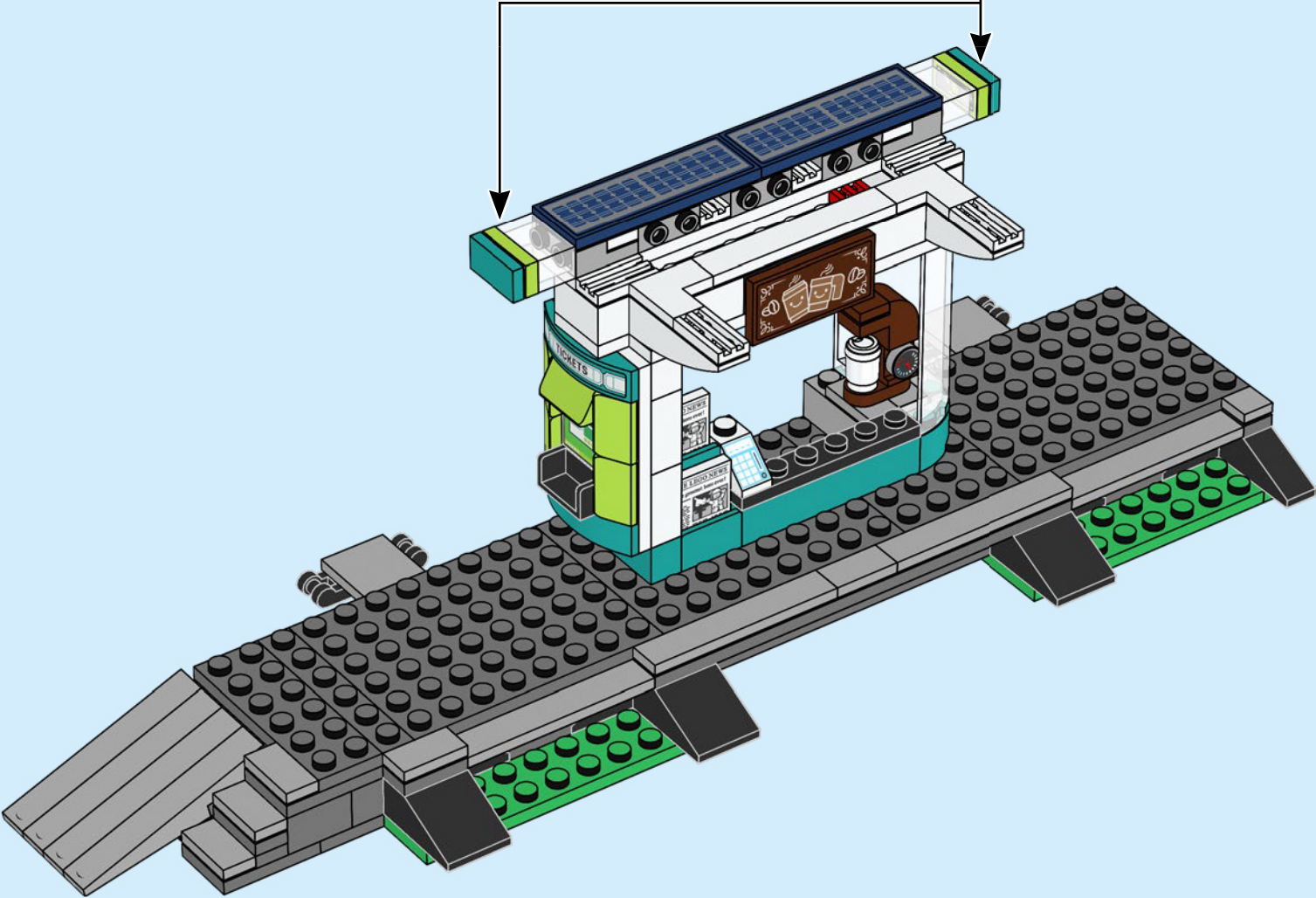
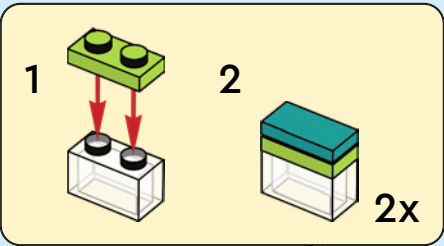

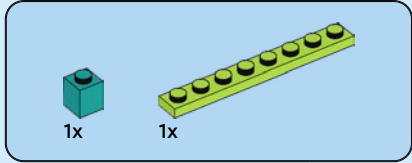
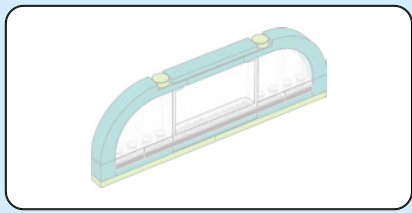

73

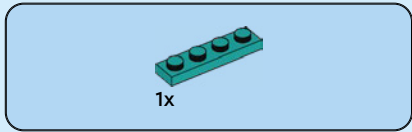
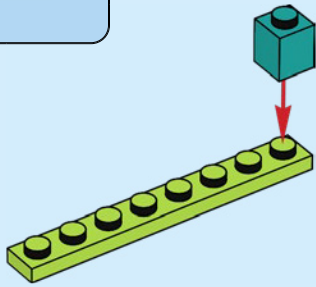

74

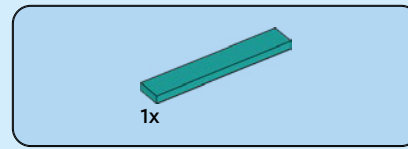
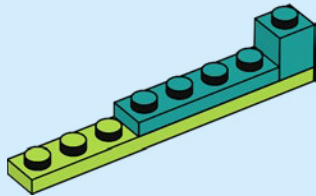

75

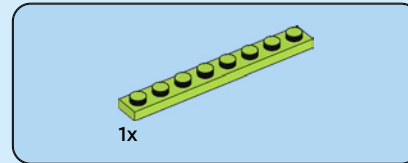
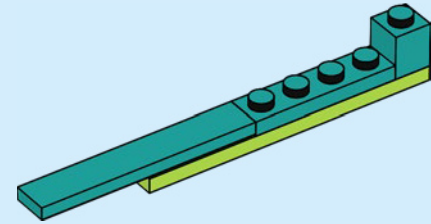

76

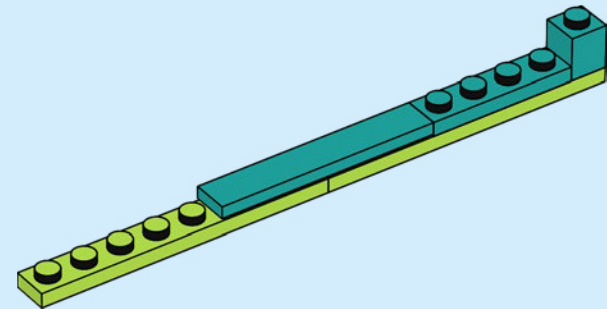

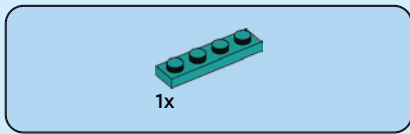

77

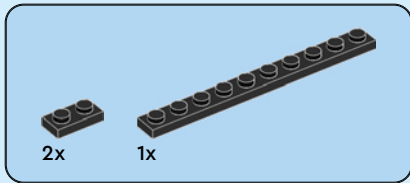
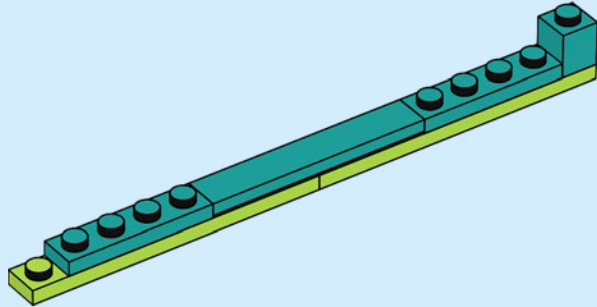

78

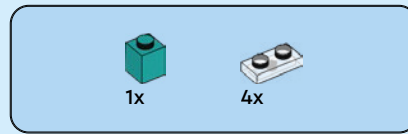
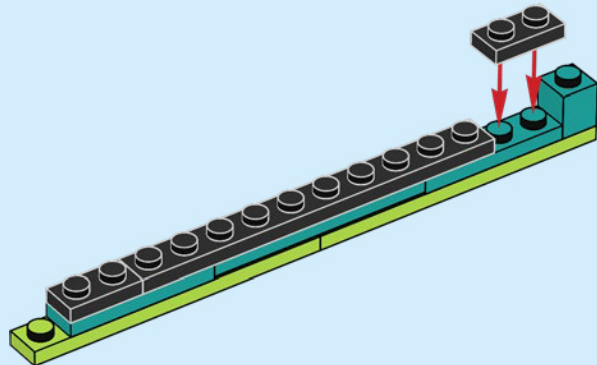

79

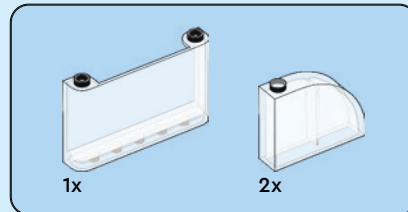
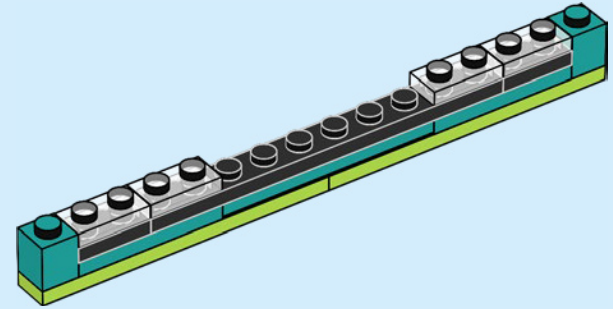

80

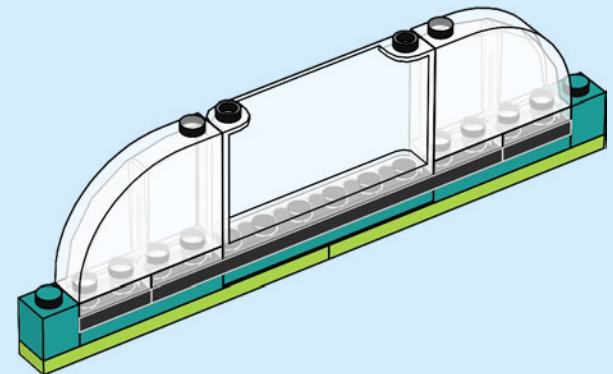

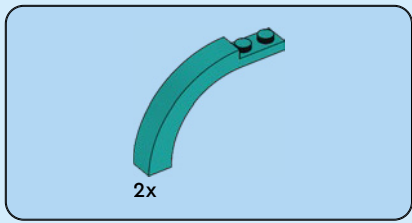

81

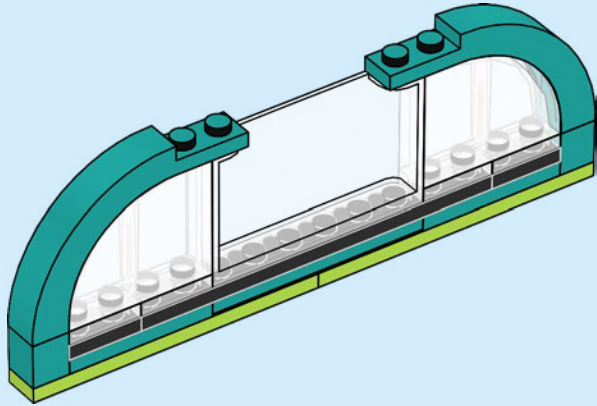

82

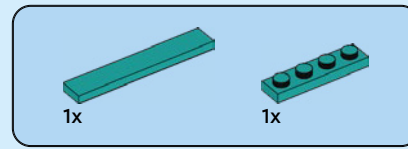
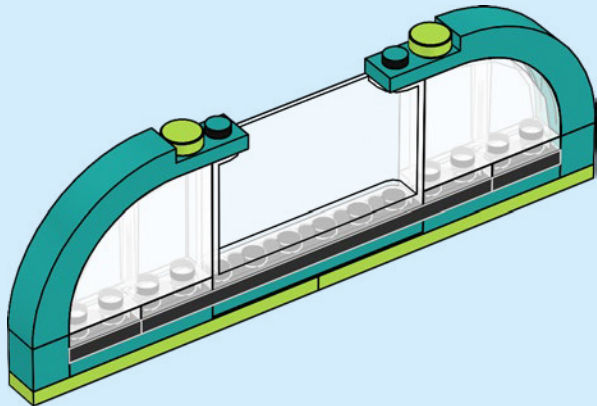

83

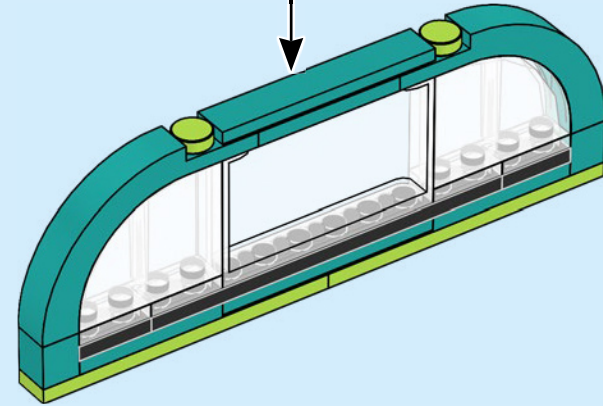
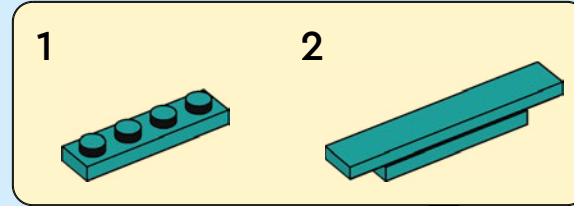

84

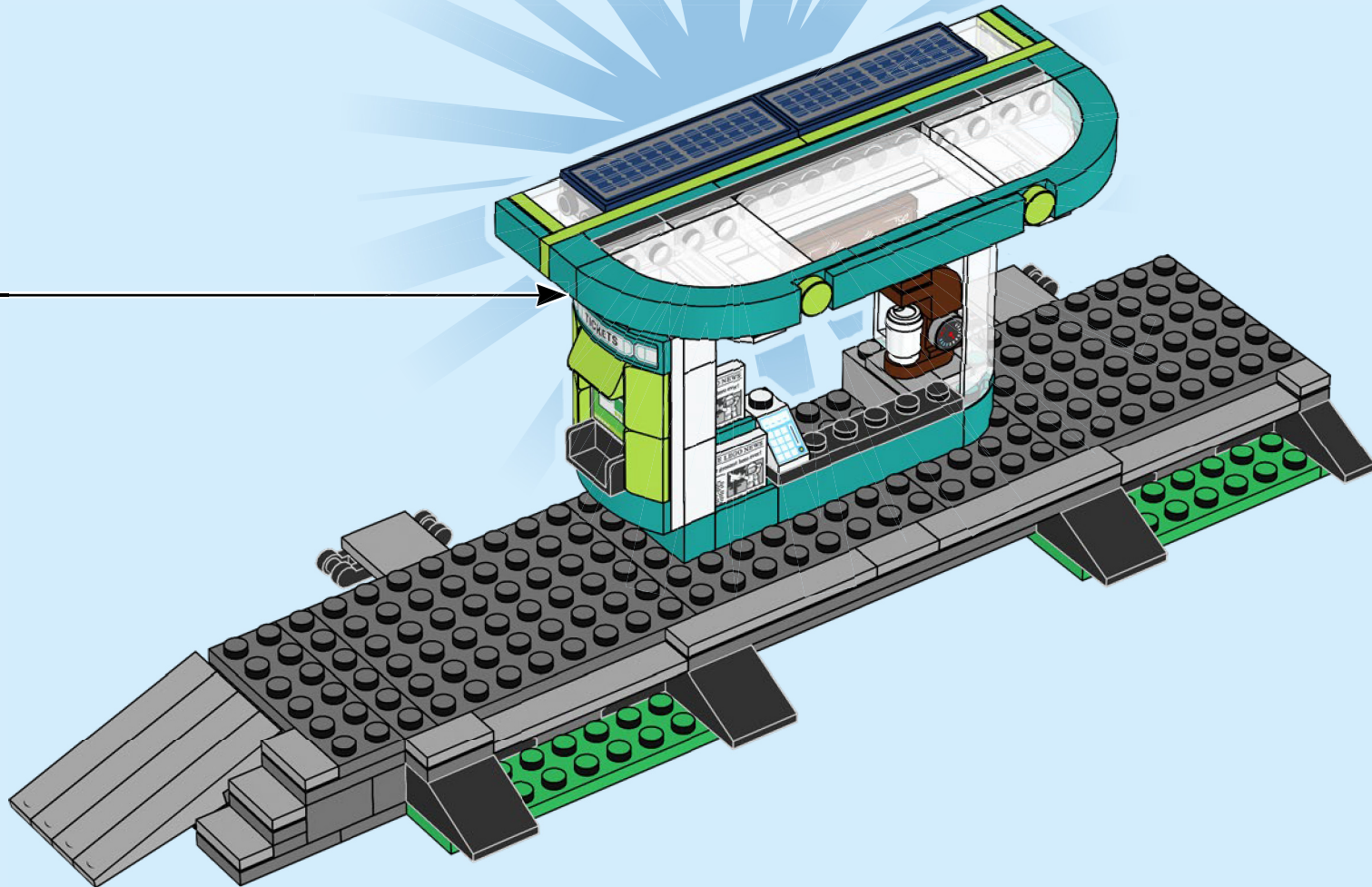

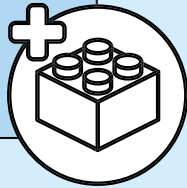
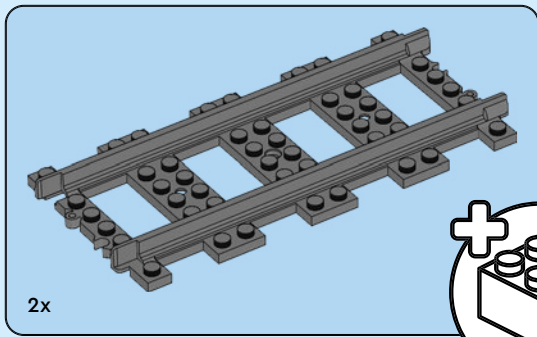

85

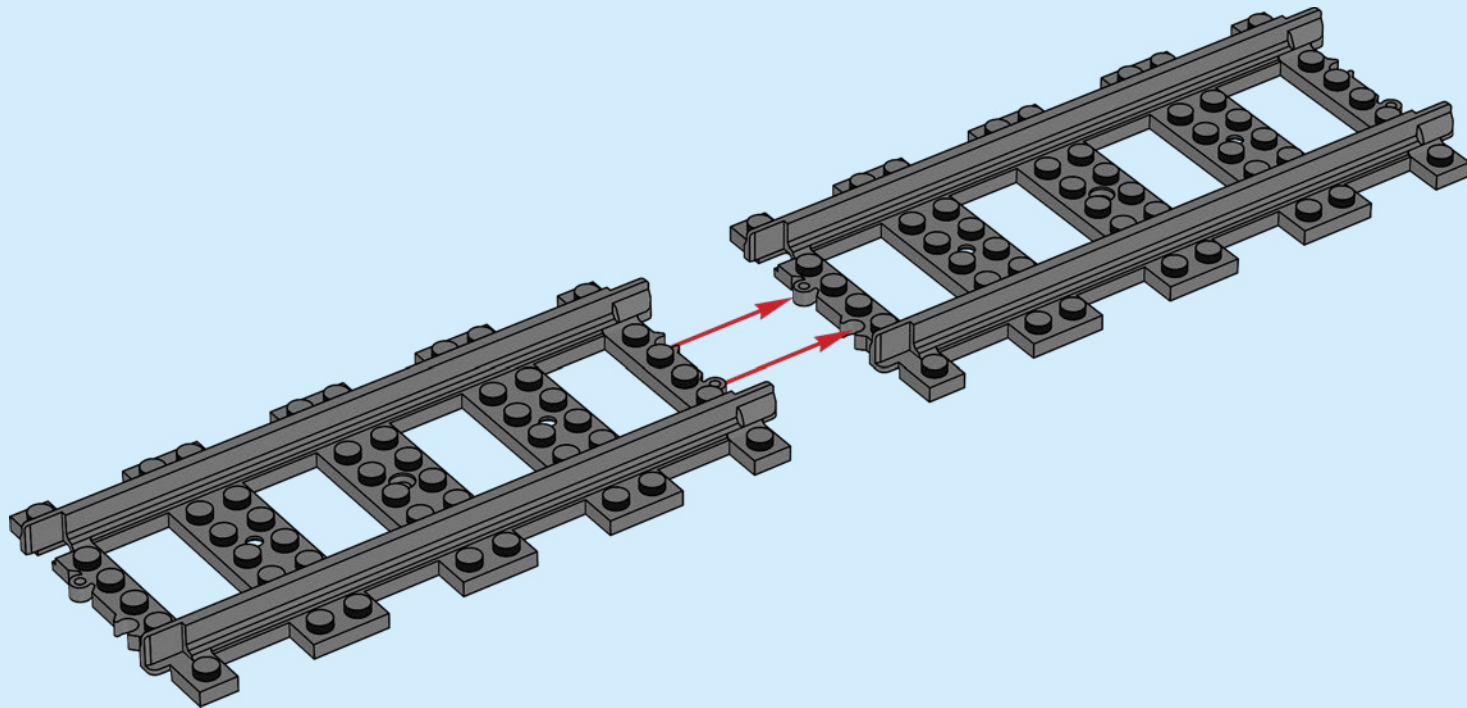

86

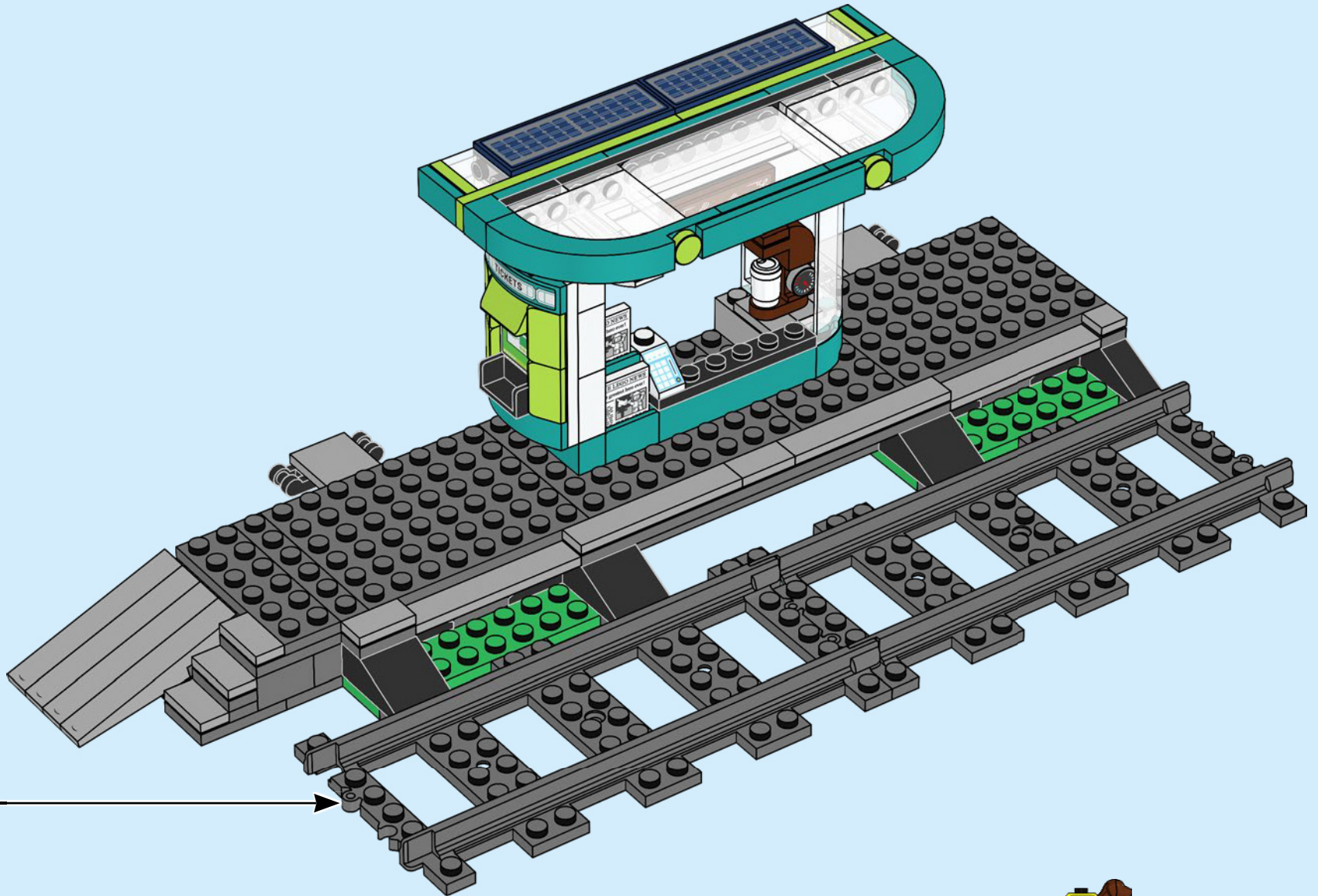

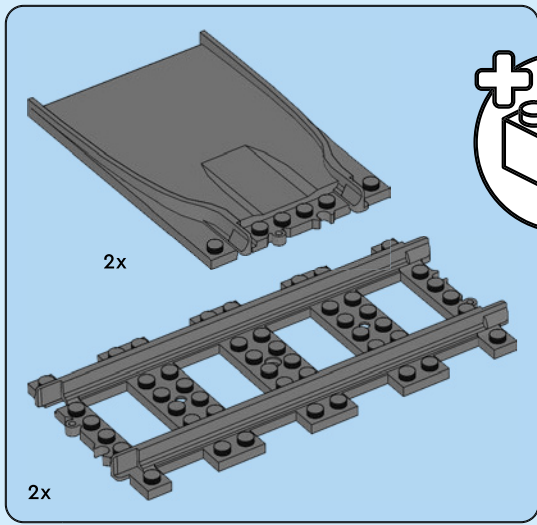

87

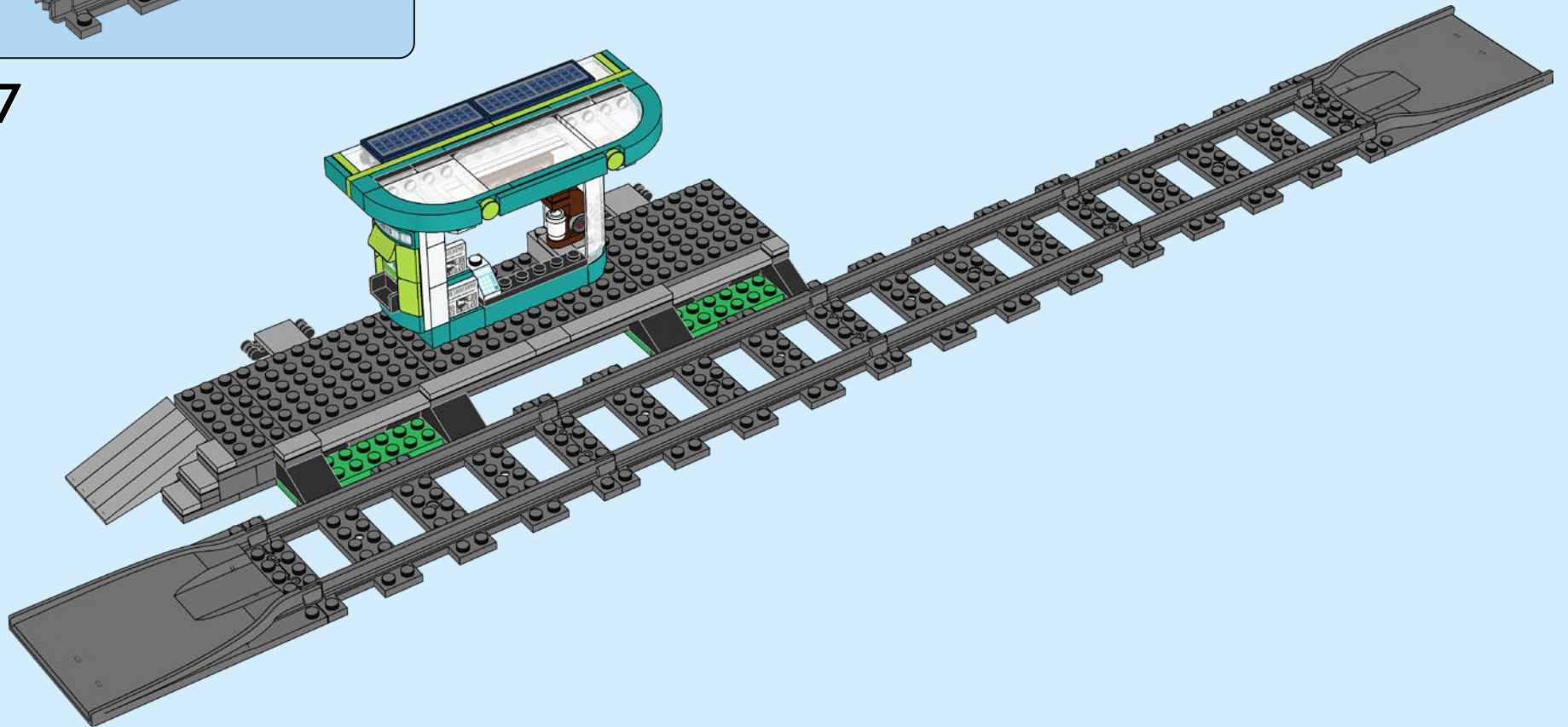

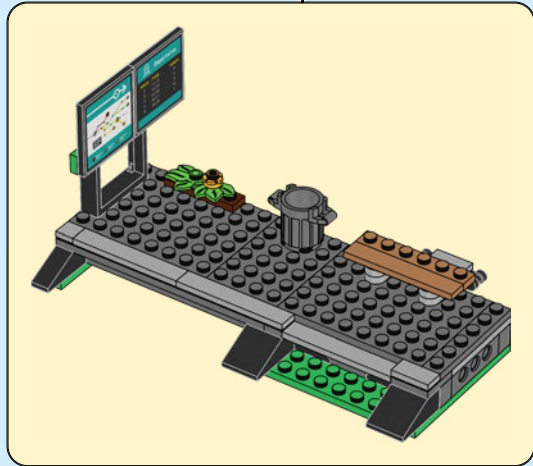
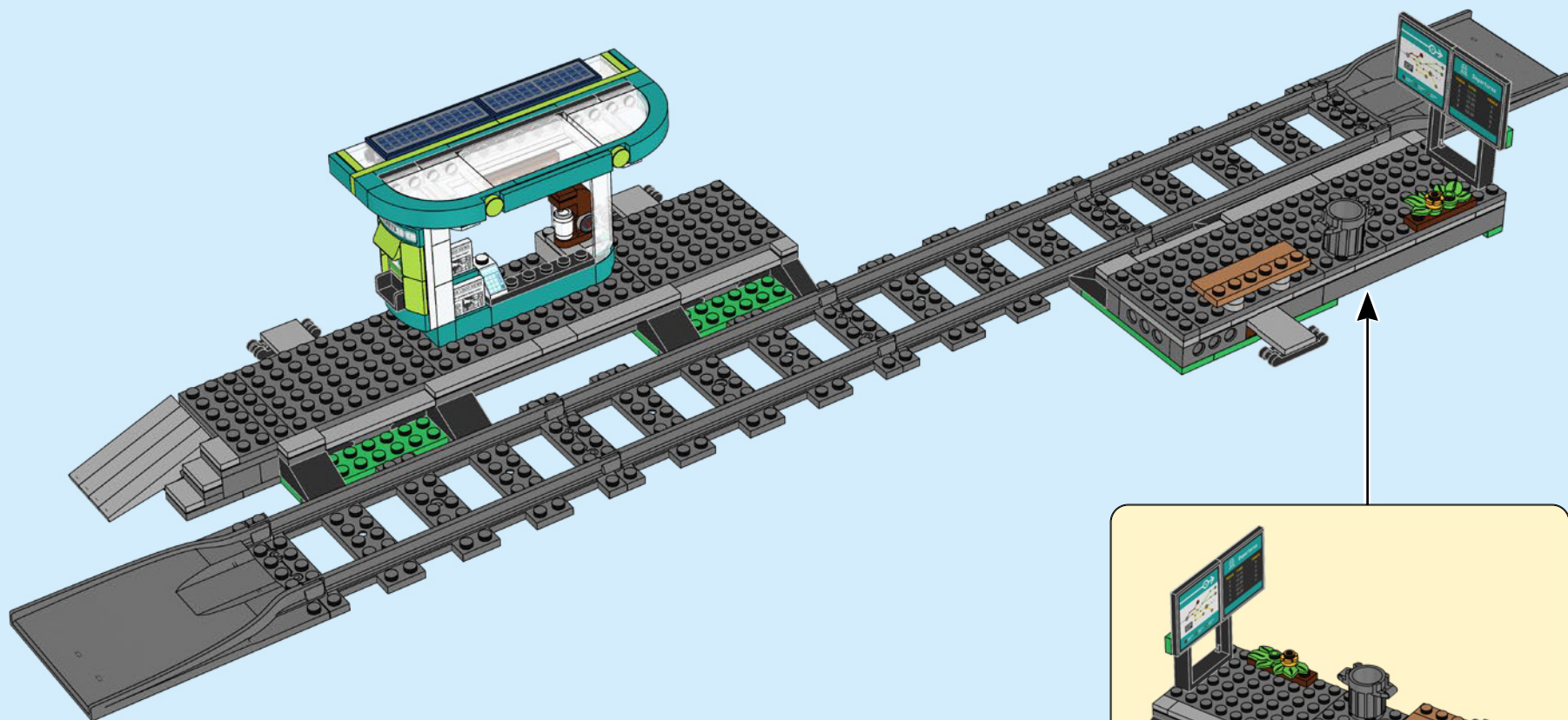





Rebuild
the
world™



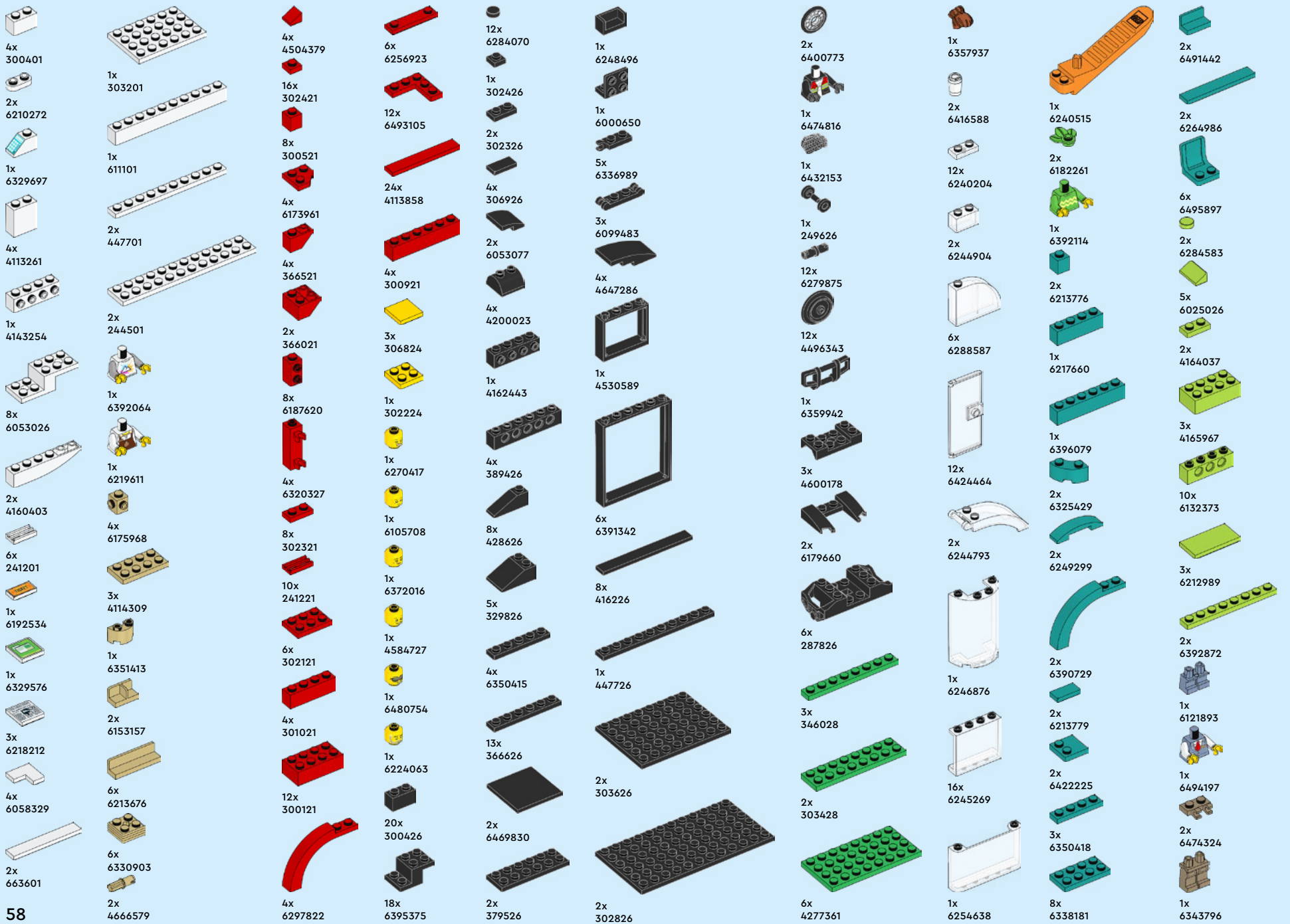



2x
6326191



1x
4162916



2x
6255896



4x
6252043



20x
6240217



1x
6209681



1x
4211288



1x
4225469



1x
6335567



6x
6433392



5x
4211190



1x
4579690



2x
6248944



1x
4221886



1x
6227107



1x
4506003



1x
6480876



2x
6135494



2x
4211428



6x
6015344



1x
4211636



1x
6028324



2x
6329152



6x
4568637



4x
6508016



3x
4211415



2x
6066097



6x
4211350



9x
4211414



1x
6329581



2x
4211413



12x
6257593



1x
4211395



2x
4560183



3x
6372029



6x
4211549



3x
6318584



10x
4211452



3x
6014617



4x
6508016



1x
6265742



9x
6469440



1x
6267048

4x
4211419



4x
6250597



4x
6248890



4x
6456718



2x
4507056



4x
6370947



1x
6430540



6x
6388353



2x
4195007



1x
6465439



1x
6494152



4x
4211098



1x
4211060



4x
4211104



4x
4211104



4x
4211090



4x
4249139



4x
4234534



7x
4211063



2x
4211094



2x
4211043



2x
4211002



2x
4211002



2x
4211115



5x
4210794



5x
4210794



4x
4210798



4x
4210798



4x
4210798



2x
6457961



2x
6117346



8x
6390673



2x
4211066



1x
6171068



1x
6432265



9x
4213607



2x
4211056



2x
4211056



2x
4211056



2x
4211056



2x
4211056



2x
4211056



2x
4211056

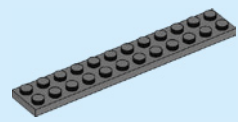

1x
4211067



1x
6000970

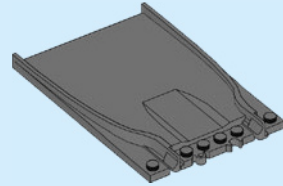

2x
6486315

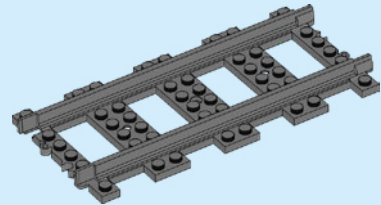

4x
6070018



1x
6329586



1x
6383968



1x
6102995



1x
6295464



1x
6145528



6x
4298979



1x
6505158



1x
6505158



1x
6505158



1x
6505158



1x
6505158



1x
6505158



1x
6505158



1x
6505158



[LEGO.com/service](https://www.LEGO.com/service)

YOU COULD **WIN**

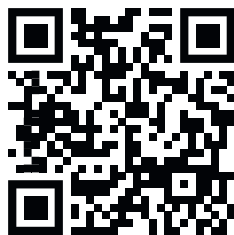

Scan this QR code or go to **LEGO.COM/PRODUCTFEEDBACK** and give us your short feedback about this LEGO® set for a chance to win a cool LEGO prize.

Terms and Conditions apply*

EN: YOU COULD WIN. Terms and Conditions apply* **DE: Du könntest GEWINNEN.** Es gelten die Teilnahmebedingungen* **FR: Tu pourrais GAGNER.** Des conditions s'appliquent* **IT: Potresti VINCERE tu.** Termini e condizioni sono applicabili* **ES: Puedes GANAR.** Aplican términos y condiciones* **PT: Poderá GANHAR.** Aplicam-se termos e condições* **ZH: 轻松获奖. 条款和条件适用*** **PL: Szansa na WYGRANĄ.** Obowiązują warunki korzystania* **CS: Máte šanci VYHRÁT.** Platí všeobecné smluvní podmínky* **SK: Máte šancu VYHRAŤ.** Platia všeobecné zmluvné podmienky* **HU: TE IS NYERHETSZ.** Felhasználási feltételek érvényesek* **RO: Ai putea CÂȘTIGA.** Se aplică termenii și condițiile* **BG: Можете да СПЕЧЕЛИТЕ.** Има определени правила и условия* **LV: Tu vari LAIMĒT.** Ir spēkā noteikumi un nosacījumi.* **ET: Sul on võimalus VÕITA.** Kehtivad tingimused* **LT: Jūs galite LAIMĖTI.** Taikomos sąlygos*

*[LEGO.com/productfeedback-terms](https://www.lego.com/productfeedback-terms)